



THIELE



Mining

CHANGE[®]
for Success





DNV-GL

MANAGEMENT SYSTEM CERTIFICATE

Certificate No.: 130032-2011-AQ-GER-DAKKS Initial certification date: 08. February 1994 Valid:

This is to certify that the management system of

 **THIELE**

THIELE GmbH & Co. KG
Werkstrasse 3, 58640 Iserlohn / Kalthof, Germany

has been found to conform to the Quality Management System standard:

ISO 9001:2008

This certificate is valid for the following scope:

Design, Development, Production, Sales and Service of link chains and conveyor chains as well as components and accessories for

- Mining
- Lifting Technology
- Bulk Material Handling

Place and date:
Essen, 23. December 2014

 **DAKKS**
Deutsche
Akreditierungsstelle
D-2M 18453-01-00

For the issuing office:
DNV GL - Business Assurance
Schlierweghof 14, 43329 Essen, Germany

Thomas Beck
Technical Manager

Link of Bill of Materials is set out in the Certification Agreement and under the Certificate itself.

DNV-GL

MANAGEMENT SYSTEM CERTIFICATE

Certificate No.: 91991-2011-AQ-GER-DAKKS Initial date: 14.08.2011 Valid:

This is to certify that the management system of

 **THIELE**

Thiele GmbH & Co. KG
Werkstrasse 3, 58640 Iserlohn / Kalthof - Germany

has been found to conform to management system standard(s):
ISO 14001:2004

This certificate is valid for the following Scope:

Design, Development, Production, Service of welded, cold and hot formed safety-components, parts for conveying technology, link chains made from alloyed special steel, austenitic, ferritic and duplex material.

Place and date:
Essen, 08.07.2014

 **DAKKS**
Deutsche
Akreditierungsstelle
D-2M 18453-01-00

For the issuing office:
DNV GL - Business Assurance
Zertifizierung und Umweltgüterer
GmbH

Wilfried Klein
Management Representative

Link of Bill of Materials is set out in the Certification Agreement and under the Certificate itself.



DNV-GL

MANAGEMENT SYSTEM CERTIFICATE

Certificate No.: 130032-2013-AQ-GER-DAKKS Initial certification date: 03. August 2013 Valid:

This is to certify that the management system of

 **THIELE**

THIELE GmbH & Co. KG
Werkstr. 3, 58640 Iserlohn/Kalthof, Germany

has been found to conform to the Energy Management System standard:

ISO 50001:2011

This certificate is valid for the following scope:

Design, Development, Production, Sales and Service of Link Chains and Conveyor Chains as well as Components and Accessories for

- Mining
- Lifting Technology
- Bulk Material Handling

Place and date:
Essen, 06. July 2014

 **DAKKS**
Deutsche
Akreditierungsstelle
D-2M 18453-01-00

For the issuing office:
DNV GL - Business Assurance
Schlierweghof 14, 43329 Essen, Germany

Thomas Beck
Technical Manager

Link of Bill of Materials is set out in the Certification Agreement and under the Certificate itself.

All information given is based on our current knowledge and expertise and is supplied without obligations or commitments. This also applies to the patent rights of third parties. Neither do we give any obligatory warranty in the legal sense as to the properties of the products described in this publication. We expressly reserve the right to change our specifications in accordance with technical progress and company developments. This does not release the buyer from his obligation to inspect all incoming products. The quality of all our products is of course guaranteed in accordance with our general terms and conditions of sale.



Contents

THIELE - Company Profile 4-5
THIELE - Drop Forging 6-7

Chain Overview / Range of Chain Grades 8-9
Breaking-Strength Comparison 10

THIELE - Corrosion Protection 11-13

-  Tectyl (TEC) 11
-  Corostar Plus (COR) 11
-  Hot-dip galvanising (TZN) 12

Overview of Round Link Chains 14

-  THD Round Link Chains DIN 22252 ..15
- TSC Round Link Chains 16
- TSD Round Link Chains 17
- TRQ Round Link Chains 18
- TIP Round Link Chains 19

Overview of Flat Type / DUALINK® Chains 20-21

-  THD Flat Type / DUALINK® Chains 22
- TSC Flat Type / DUALINK® Chains 23
- TSD Flat Type / DUALINK® Chains 24
- TIP Flat Type / DUALINK® Chains 25



Overview of Super Flat Type Chains REINFORCED 26-27

-  THD / TSC / TSD / TIP / TZN Super Flat Type Chains REINFORCED 28-29









Overview of BIG-T® Chains 30

-  THD BIG-T® Chains 31

Overview of BROADBAND Low Profile Chains 32-34

-  BROADBAND Low Profile Chain grade THD / TIP / TSC 32-33
-  BROADBAND Low Profile Chain Connectors 34

Overview of Chain Connectors 35

-  Flat Type Connectors 36
-  TKF Connectors 36
-  DMK Connectors 37
-  SP Connectors 37
-  SP-S Connectors 38-39
-  BLOCKMASTER® 40-43
-  PLOWMASTER®-S 44
-  Power Chain Connectors 45

Overview of Flight Bars 46

-  S-Type Flight Bars (symmetrical bars) .47-49
-  E-Type Flight Bars (split-type) 50-51
-  Single-strand Flight Bars 52
- Induction-hardened tips 53

Overview of Outboard Chain Assemblies 54

-  Outboard Chain Flight Bars DIN 22257 .54
- Outboard Chain Connectors DIN 22253 .55

Sprocket Rings / Assemblies 56-57

- 

Cardan Chains 58

Bushed Conveyor Chains 59

Forged Link Chains 59

Lifting Points GK8 / XL 60-61

- 

TM-Chain Blocks 62-63

TM-Lever Blocks 62-63

- 
- 

Accessories 64-66

-  Chain Gauge 64
-  Chain Saws 65
-  Pretensometer 66

Operating Instructions 66

How to find us 67

THIELE – company profile

The THIELE company

The THIELE company was founded more than 80 years ago and is now one of the world's leading chain manufacturers. THIELE's product line includes round-link chains, bush conveyor chains, forged conveyor chains and a full range of fittings and accessories. THIELE's know-how has been built up over many years of designing and producing complete chain systems. Our highly skilled workforce and modern, high-performance production facilities stand guarantee for products of the finest quality.

Consulting and product development

THIELE specialises in chain systems for conveying and lifting. THIELE engineers provide an on-site consulting service and work alongside the client to analyse the technical requirements before planning and sizing up the moving chain assembly. Customised solutions are then worked out in detail in THIELE's own design department.

Chain production

All our chains and components are manufactured in-house. Our production facilities include equipment for welding, laser-, plasma- and gas-cutting, solid forming, heat treatment and mechanical processing using the latest CNC lathes and multi-spindle milling machines.

Quality

High-integrity production methods are used to ensure that all products leaving the THIELE factory are of the finest quality, as confirmed by continuous monitoring in our laboratory and testing house. THIELE was one of the world's first chain making companies to meet the DIN EN ISO 9001 quality management standard.

Environment

Our production procedures and processes involve considerable consumption of materials and energy resources. At THIELE we therefore have a special responsibility to continuously improve the environmental compatibility of our products, reduce the consumption of pollutants and simultaneously reduce the use of natural resources in the manufacturing process. Our emergency action plans also ensure that we react appropriately in emergency situations. Environmental protection benefits both the conservation of natural resources and THIELE's continued development. This is why we strive for affordable, environmentally and socially compatible contractual solutions for our products, from their manufacture to their disposal. The continuous improvement of all our production processes combined with a reduction of the environmental impact is an inherent part of our corporate philosophy.

Customs

The increased globalization and the changed global security situation have caused the EU to introduce the status of an "Authorised Economic Operator" (AEO) as a form of effective risk management within the customs administrations. The aim is to secure the continuous global supply chain from the manufacturer to the end-user. The company THIELE has furnished proof that it is a reliable trading partner and it has already been in possession of an AEO certificate since 2010.



Development, CAD design, chain dimensioning

All product development takes place in our own technical department, where the latest 3D CAD programs are used in the design of mining chains, connectors, flight bars and forging dies. Precise volume calculations enable us to reduce material costs during forging. 3D CAD programs are also used to simulate complex chain routings over sprocket wheels and in conveyor installations.



Production line

THIELE mining products are manufactured at the Iserlohn-Kalthof plant where the facilities include the latest welding and bending machines, forging hammers, CNC machines and heat treatment lines.



Service

The company operates a mobile chain testing service whereby accredited technicians are able to carry out chain testing in-situ. We can offer a full inspection program for chain conveyors and also carry out chain wear measurements on request. Specialists are also available to oversee chain assembly and commissioning of your conveyor systems.

Clients can also have their conveyor chains checked for wear, material fatigue and corrosion in our in-house laboratory, thereby providing them with reliable information on remaining chain life.

THIELE – drop forging plant

Forgings weighing between 0.1 kg and 60 kg, and measuring up to 1000 mm, are produced on three forging hammers – 31.5 kJ, 40 kJ and 100 kJ (10 kJ is equivalent to an impact energy of 1 tonne from a 1 m height of drop) – and a 1,600-tonne forging press. The feedstock comprises square billets with edge lengths of between 20 and 120 mm or round billets 18.5 to 60 mm in diameter.

The material is first cut to size by cropping or sawing before the individual segments are heated in an induction unit assigned to the respective forging machine. The heated blanks are then reshaped in a die using pneumatically generated impact energy or by a forming force applied via a centrifugal mass. The flash is then removed from the finished piece. The forming process often involves working to extremely fine tolerances.

After forging the components undergo careful heat treatment in order to fine-tune their final properties.

At THIELE we make all our dies and trimming and calibration tools in-house. We also employ program-controlled machines that can produce shapes using the latest technology, including high-speed milling.



A horizontal chain of metal links spans the width of the page at the top.

Forging with quality assurance

An experienced workforce combined with reliable production methods are the key to real quality assurance.

All key product characteristics are continuously monitored in a series of elaborate routines that are carried out at THIELE's in-house testing and laboratory facilities.

This includes comprehensive crack testing of all forged chain links.

Benefits:

- all forgings FEM-optimised
- drop forged according to grain direction
- calibrated chain recesses on flight bars
- precise heat treatment and machining

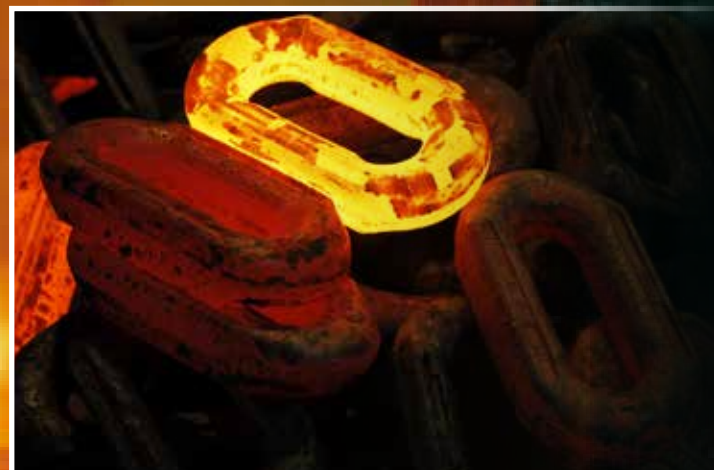



THIELE Chain Overview

To ensure that its products can meet the tough demands of today's mining industry THIELE has developed its own chain steels based on many years of manufacturing know-how. Each production stage is accompanied by careful and thorough quality control tests. THIELE chains are recognised the world over for their performance and durability.



Round Link Chains
Page 14-19



Flat Type Chains
Page 20-25



DUALINK®-Chains
Page 20-25



Super Flat Type Chains
Page 26-29



BIG-T® Chains
Page 30-31



BROADBAND Chain
Page 32-33

One important factor to be considered when it comes to low-height conveyors is that the conveyor chain has to be designed for a minimum headroom requirement (the b4 dimension). Operators frequently demand the maximum possible chain thickness for a given design height. THIELE's range of chains are graded in ascending order so that the same profile pan can be fitted with the next-largest nominal size (= nominal diameter).

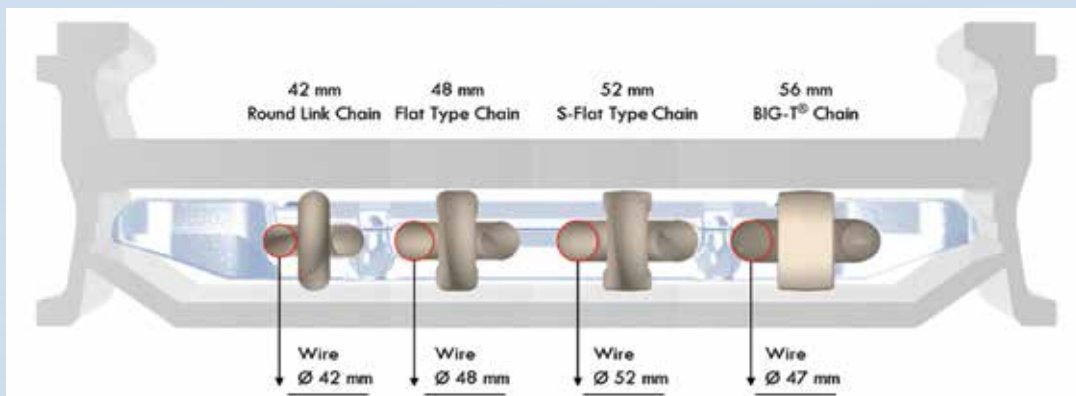

If a larger-size chain is installed in the same profile height the scraper bar will inevitably be weakened in the chain seat. With the BIG-T chain the round link in the chain seat is tapered so that the scraper bar can retain its critical flight profile.



THIELE's range of chain grades

By using a computer-controlled calibration process THIELE is able to supply paired chain strands to any length requirement. The company can provide a wide range of chain grades to meet all kinds of operating conditions:

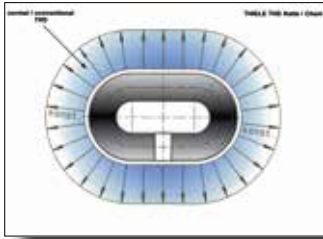

THD (THIELE Heavy Duty)

Round Link Chains	DIN 22252	page 15
Flat Type / DUALINK Chains	TWN 0102	page 22
Super Flat Type Chains / S-Flat REINFORCED		page 29
BIG-T		page 31
Broadband Low Profile Chain		page 32

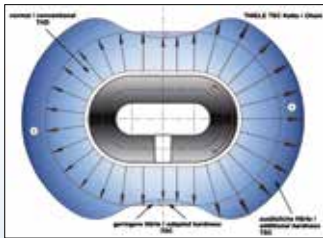

TSC (THIELE Super Crown)

Round Link Chains	TWN 0100	page 16
Flat Type / DUALINK Chains	TWN 0026	page 23
Super Flat Type Chains / S-Flat REINFORCED		page 29
Broadband Low Profile Chain		page 33

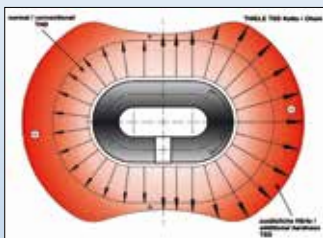

TSD (THIELE Super Duty)

Round Link Chains	TWN 0024	page 17
Flat Type / DUALINK Chains	TWN 0025	page 24
Super Flat Type Chains / S-Flat REINFORCED		page 29
BIG-T		page 31

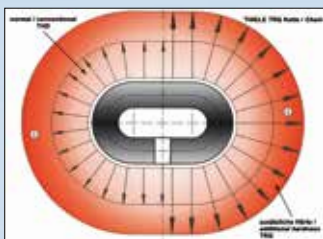

TRQ (THIELE Rock Quality)

Round Link Chains	TWN 0108	page 18
Flat Type / DUALINK Chains		on request

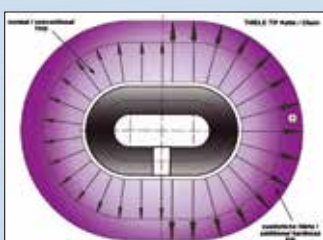

TIP (THIELE Improved Performance)

Round Link Chains		page 19
Flat Type / DUALINK Chains		page 25
Super Flat Type Chains / S-Flat REINFORCED		page 29
BIG-T		on request
Broadband Low Profile Chain		page 33



Breaking-strength comparison for THIELE chain grades

In the elastic range (up to the testing force) all chains exhibit the same characteristic because their elastic elongation is determined by their geometry alone.

Plastic (permanent) deformation only sets in when the load applied begins to exceed the testing force. Because of the higher hardness levels of TSD and TSD Chains, correspondingly higher forces are needed to produce plastic deformation here.

Whatever the steel, increasing hardness naturally goes hand in hand with a reduction in the ultimate elongation or deformability of the material. This means that TSD and TSD Chains exhibit lower levels of elongation at break.

By using a special grade (TIP) of mining chain steel THIELE is able to increase the breaking force, hardness and wear resistance by approx. 5% while retaining the chain's impact strength and deformability.

For TIP Chains the testing forces and breaking forces are therefore some 5% higher with no loss in ultimate elongation.

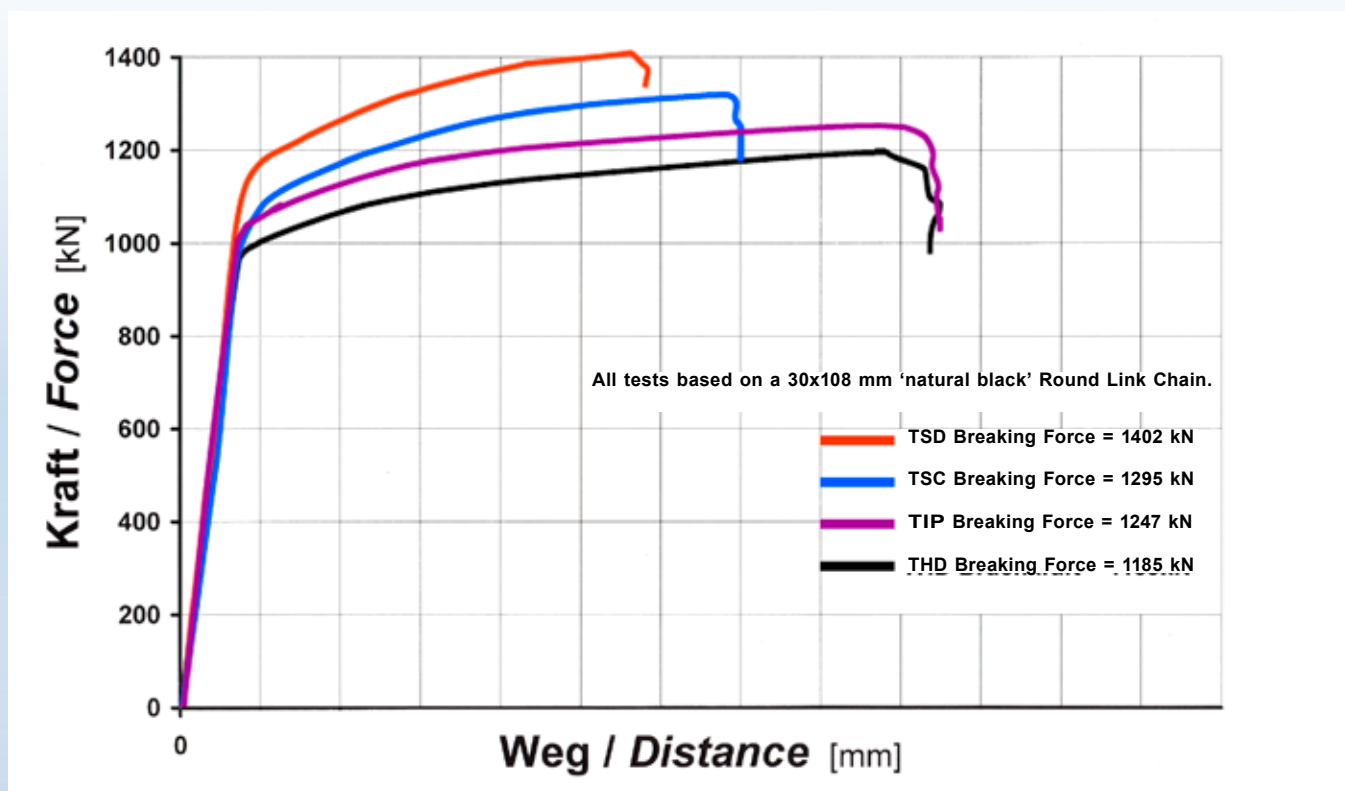



THIELE corrosion protection

1. Tectyl (TEC)

After heat treatment the chain surface can be described as 'natural black'. As corrosion products can form on this surface after just a few days in storage all THIELE chains – unless corrosion protected in some other way – are coated with Tectyl (TEC) for transport purposes. Tectyl is also a proven means for preventing corrosion during storage.

The duration of the corrosion protection afforded by Tectyl will depend on the weather and climatic conditions. Experience shows that chains whose Tectyl coatings remain intact are still fully fit for service after several months of storage outdoors.

Tectyl also acts as a running-in lubricant in that it eases the bedding-in process (progressive initial wear) that the chain links have to go through.



2. Corostar Plus (COR)

Corostar Plus (COR) is a zinc-rich paint containing specially developed additives. It reduces friction at the chain links and is widely used to improve the running-in lubrication effect – especially in the case of plough chains.

THIELE corrosion protection

3. Hot-dip galvanising (TZN)

A considerable number of mines face very corrosive conditions. This is why THIELE has developed hot-dip galvanising (TZN) technology for chains intended for operating conditions of this type.

During the hot-dip galvanising process a permanent corrosion-proof coating is formed on the surface of the chain. This coating comprises two layers: an iron-zinc intermetallic phase and a solid zinc surface coating. This protective layer is smooth, non porous, highly adherent and therefore abrasion resistant. Even those surfaces that are exposed during underground service are still protected from corrosive attack. The phenomenon on which this observation is based is known as electrochemical or cathodic galvanising protection.

Long-term observations show that hot-dip galvanised chains have a greatly improved service life and chain failures are reduced dramatically.

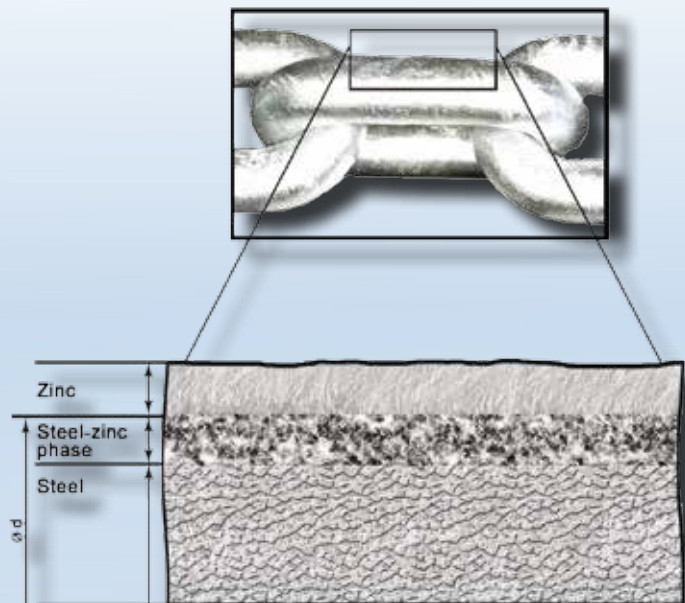

Hot-dip galvanising is the only effective and proven form of corrosion protection for mining chains.

THIELE corrosion protection

THIELE offers the following corrosion protection options to meet different underground conditions and storage times:

- a) Tectyl dipping (TEC) – for short storage times and favourable conditions (page 11)
- b) Corostar Plus (COR) – particularly as ‘running in’ protection for plough chains (page 11)
- c) Hot-dip galvanising (TZN) – for longer storage periods or corrosive operating conditions (page 12)

For technical reasons (see DIN 22252) final testing is carried out before the corrosion protection is applied. The breaking force and ultimate elongation values therefore apply to the chain in its ‘natural black’ condition. Hot-dip galvanised chains are an exception in that they are again tested after galvanising.

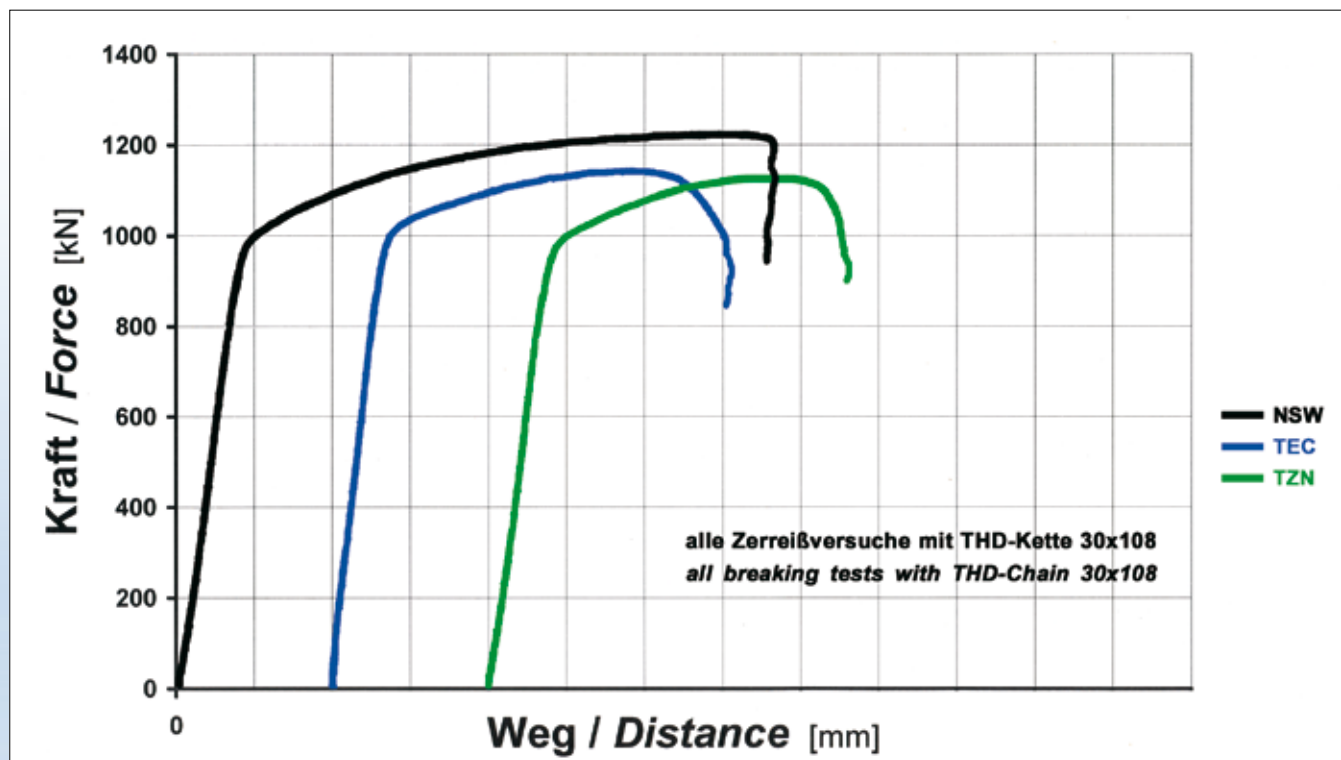

The chain breaking forces given in the relevant standards and catalogues refer to tensile tests on a ‘natural black’ chain surface of the type produced after heat treatment. This surface is covered with scale and typically exhibits a high degree of roughness and a high frictional resistance.

Each corrosion layer, whether Tectyl, Corostar or zinc, reduces the breaking force of the THD chains by up to 10% and the ultimate elongation by as much as 20% when compared with the catalogue values (see also DIN 22252 and DIN 22255). The first contact with the conveyed product also produces the same result.

The application of an anti-corrosion layer does not however affect the quality or functionality of mining grade chains. It merely reduces the frictional resistance at the chain-link pivot points and the resulting breaking force and ultimate elongation values. The relevant chain-quality values, namely testing force, test elongation and operating force, along with the material strength, remain unchanged.



THIELE Round Link Chains

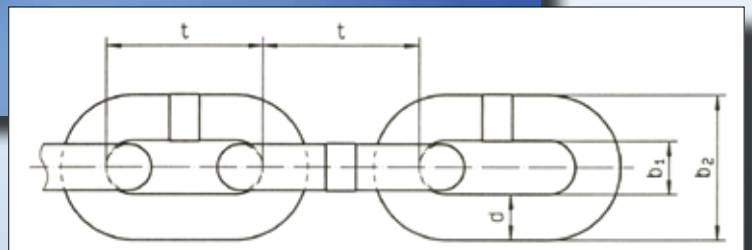
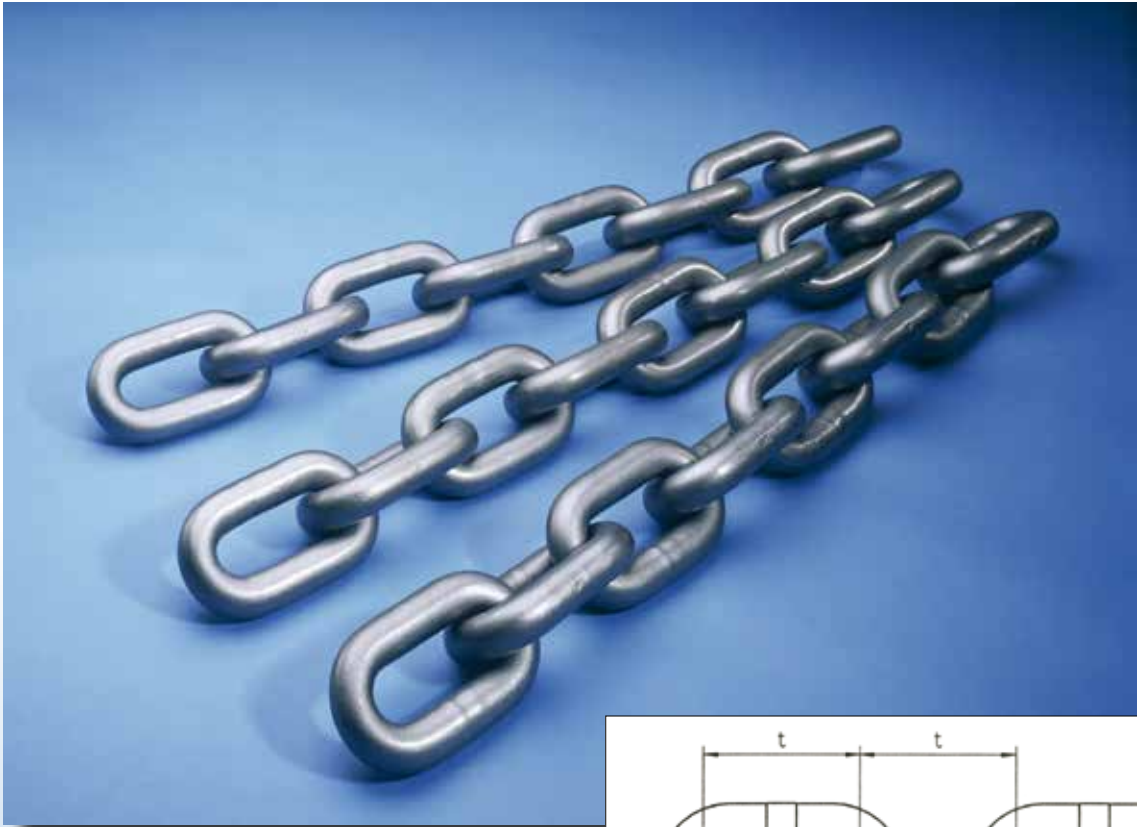

Weights and Dimensions (THD; TSC; TSD; TRQ; TIP; TZN)

Chain Size	Diameter	Pitch	Inside Width	Outside Width	Length at n	Weight
d x t [mm]	d	t	b ₁ min.	b ₂ max.	5 x t	[kg/m]
14 x 50	14 ± 0,4	50 ± 0,5	17	48	250 ± 1,0	4,0
18 x 64	18 ± 0,5	64 ± 0,6	21	60	320 ± 1,0	6,6
19 x 64,5	19 ± 0,6	64,5 ± 0,6	22	63	322,5 ± 1,0	7,6
22 x 86	22 ± 0,7	86 ± 0,9	26	73	430 ± 1,0	9,5
24 x 86	24 ± 0,7	86 ± 0,9	28	79	430 ± 1,0	11,6
26 x 92	26 ± 0,8	92 ± 0,9	30	85	460 ± 1,0	13,7
30 x 108	30 ± 0,9	108 ± 1,1	34	97	540 ± 1,2	18,0
34 x 126	34 ± 1,0	126 ± 1,3	38	109	630 ± 1,3	22,7
38 x 137	38 ± 1,1	137 ± 1,4	42	121	685 ± 1,4	29,0
42 x 137	42 ± 1,1	137 ± 1,4	48	139	685 ± 1,4	36,6



THIELE Heavy Duty (THD)

DIN 22252

THIELE round-link chains can be used on both face conveyors and stage loaders and are also suitable as traction elements for coal ploughs. To ensure that its products can meet the tough demands of today's mining industry THIELE has developed its own chain steels based on many years of manufacturing know-how.

Each production stage is accompanied by careful and thorough quality control tests. THIELE chains are recognised the world over for their performance and durability.

This is why THD round-link steel chains are hardened and tempered to a strength of 345 – 375 HB10 (which applies uniformly over the entire link). For chains intended for face conveyors this strength level represents the optimum in terms of impact resistance (notch impact strength) and wear resistance (hardness).

Important for converting hardness measurements into tensile strength:

The strength specification of all THIELE chains is based on hardness measurements according to the Brinell scale.

Converting hardness measurements into tensile strength [MPa] has until now been carried out using Table A1 in DIN EN ISO 18265. The new DIN 22252 / 22255 however has changed over to Table B2. The quality grade and hardness specification for THIELE chains remains unchanged. Applying Table B2 produces a different set of tensile strengths from those of Table A1.

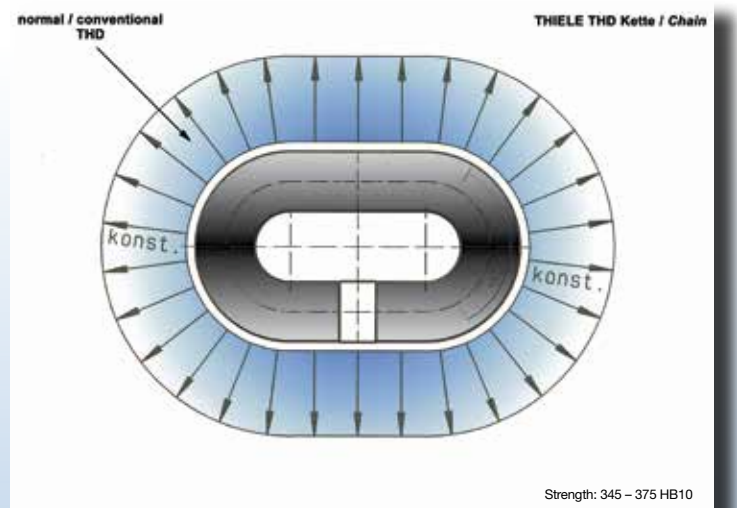

Mechanical Properties (THD; TZN)

Chain Size d x t [mm]	Article No. TEC	Article No. TZN	Test Force kN	Elongation under test force % max.	Breaking Force kN min.	Elongation at fracture %	Minimum Deflection [mm]
14 x 50	F13101	F13195	185	1,6	246	14	14
18 x 64	F13206	F13212	305	1,6	407	14	18
19 x 64,5	F13311	F13350	340	1,6	454	14	19
22 x 86	F13401	F13402	456	1,6	608	14	22
24 x 86	F13482	F13483	543	1,6	724	14	24
26 x 92	F13513	F13499	637	1,6	850	14	26
30 x 108	F13653	F13657	848	1,6	1.130	14	30
34 x 126	F13813	F13820	1.090	1,6	1.450	14	34
38 x 137	F13877	F138972	1.360	1,6	1.820	14	38
42 x 137	F15093	F15096	1.660	1,6	2.220	14	42

the above values apply to chains in 'natural black' condition (NSW)



THIELE Super Crown (TSC)

TWN 0100

THIELE developed the TSC series of Round Link Chains with wear-resistant crowns (THIELE Super Crown) in order to reduce link wear on plough chains and increase chain operating life.

As frictional heat in the fast running plough chains (which travel at over 3.0 m/s) leads to hardening of the legs and to dangerous crack formation the material strength of the legs is deliberately reduced by secondary heat treatment – thereby increasing the crack arrest capacity.

THIELE TSC chains are widely used on chain scraper conveyors because of the increased hardness of their crowns. This extra hardness rating inevitably means that the chains are more susceptible to stress corrosion cracking and so TSC Chains are not recommended for corrosive environments – especially when fitted to face conveyors.

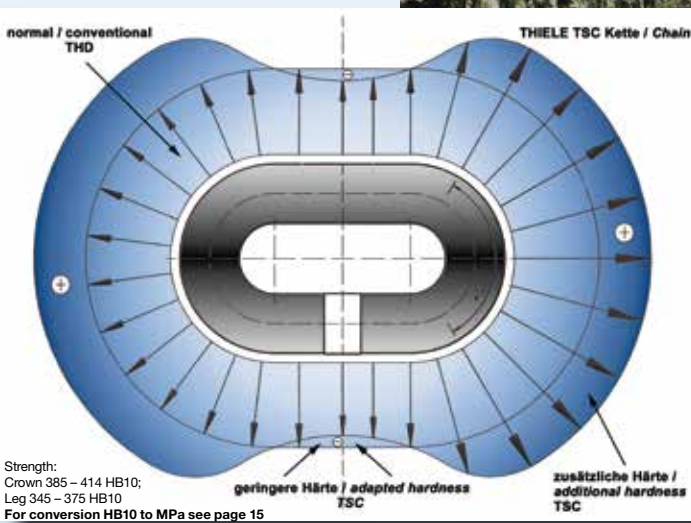
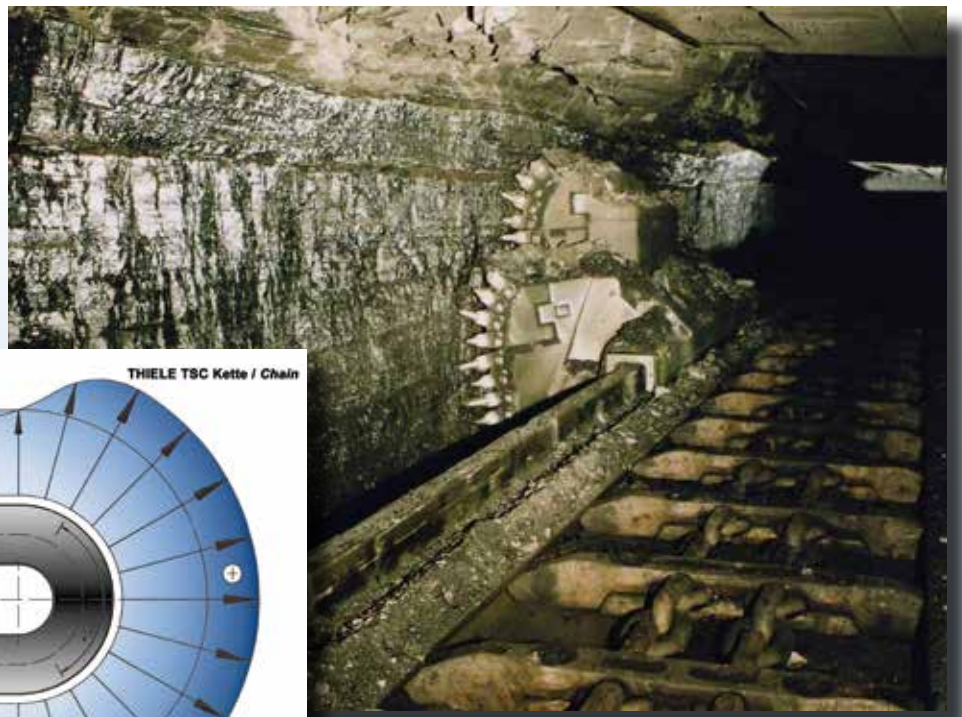

Picture: RAG

Chain Size d x t [mm]	Article No.	Test Force kN	Elongation under test force % max.	Breaking Force kN min.	Elongation at fracture %	Minimum Deflection [mm]
22 x 86	F13394	456	1,4	670	18	22
26 x 92	F13506	637	1,4	940	18	26
30 x 108	F13646	848	1,4	1.250	18	30
34 x 126	F13872	1.090	1,4	1.610	18	34
38 x 137	F15090	1.360	1,4	2.010	18	38
42 x 137	F15095	1.660	1,4	2.220	18	42
42 x 137	F15094	1.660	1,6	2.450	14	42

the above values apply to chains in 'natural black' condition (NSW)

THIELE Super Duty (TSD)

TWN 0024

Like TRQ Chains, THIELE TSD Round Link Chains (THIELE Super Duty) were developed in order to achieve the greatest possible wear resistance when used on chain scraper conveyors and a higher breaking force. The material strength of the legs is deliberately reduced by precise heat treatment, which increases the crack arrest capacity in order to prevent cracking caused by the friction martensite as a result of chain speeds of > 0.5 m/s. This makes TSD Chains ideally suited for use on stage loaders (BSL).

The extreme crown hardness of TSD Chains results in a very high wear resistance and a higher breaking force too. The latter is however an unintentional side effect. As the increased hardness also means a reduction in toughness and a greater sensitivity to stress corrosion cracking TSD Chains are not recommended for use on face conveyors operating in a corrosive environment.

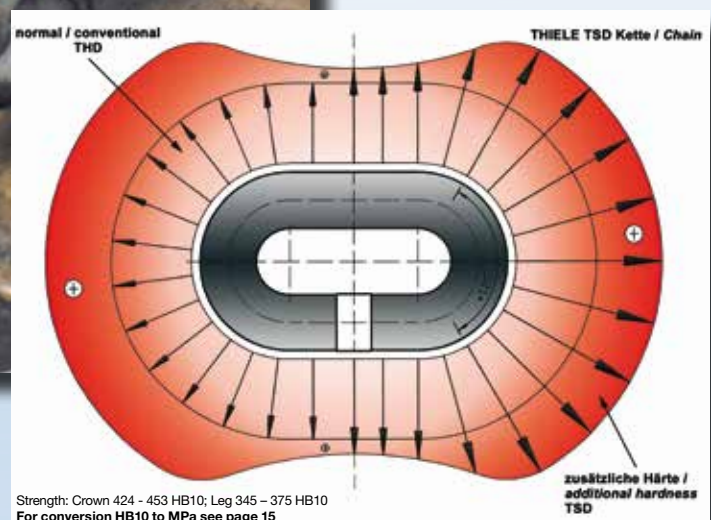
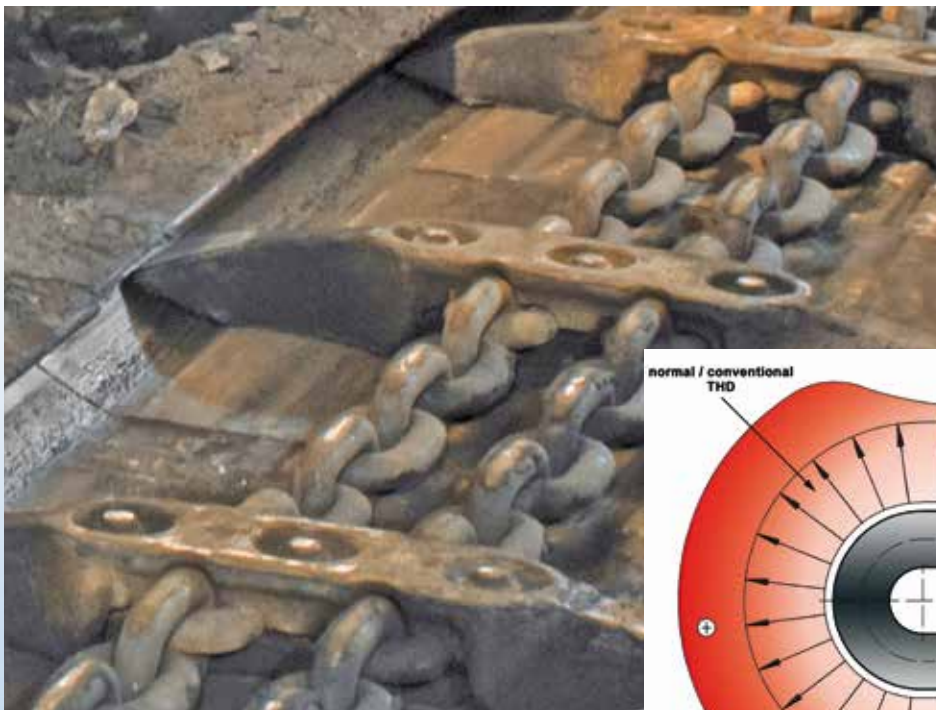

Chain Size d x t [mm]	Article No.	Test Force kN	Elongation under test force % max.	Breaking Force kN min.	Elongation at fracture %	Minimum Deflection [mm]
22 x 86	F14009	530	1,6	750	16	18
24 x 86	F13454	630	1,6	900	16	19
26 x 92	F14005	740	1,6	1.050	16	21
30 x 108	F14045	990	1,6	1.400	16	24
34 x 126	F14077	1.270	1,6	1.800	16	27
38 x 137	F14085	1.590	1,6	2.250	16	30

the above values apply to chains in 'natural black' condition (NSW)

THIELE Rock Quality (TRQ)

TWN 0108

THIELE Rock Quality Chains (TRQ) were specially developed for the conveying of abrasive materials in stone drifts and roadway drivages. Careful tempering ensures hardness levels of 424 - 453 HB over the entire cross-section of the material and a uniform surface hardness at any point on the chain link.

The TRQ Chain also exhibits a high tensile strength with a fracture stress of 1000 N/mm². The combination of tensile strength and hardness opens up opportunities for use in difficult conveying situations where high tensile loads would rule out the use of surface hardened chains.

TRQ Chains can be operated up to a maximum speed of 0.5 m/s, as the frictional heat generated at higher chain speeds would result in hardening of the shanks and lead to dangerous crack formation.

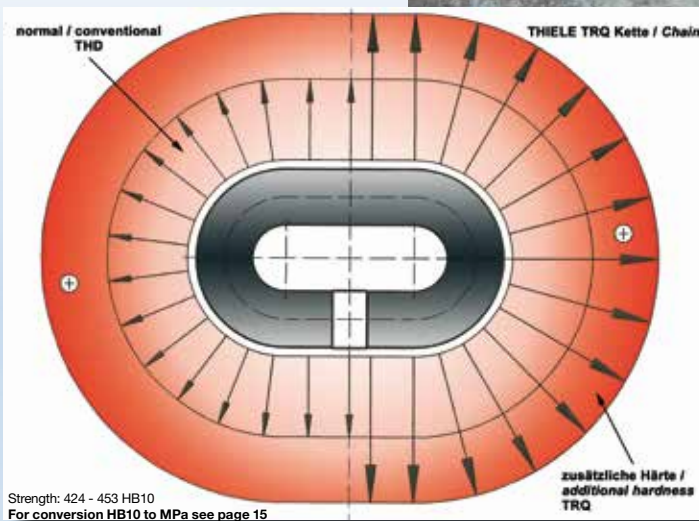

Chain Size d x t [mm]	Article No.	Test Force kN	Elongation under test force % max.	Breaking Force kN min.	Elongation at fracture %	Minimum Deflection [mm]
18 x 64	F13209	320	1,6	510	12	18
19 x 64,5	F13314	360	1,6	570	12	19
22 x 86	F13405	480	1,6	760	12	22
26 x 92	F13518	670	1,6	1.060	12	26
30 x 108	F13660	890	1,6	1.410	12	30
34 x 126	F13805	1.140	1,6	1.820	12	34
38 x 137	F15091	1.430	1,6	2.270	12	38

the above values apply to chains in 'natural black' condition (NSW)



THIELE Improved Performance (TIP)

THIELE TIP Round Link Chains have been developed for use on high-performance coal faces. By employing special alloyed steel the main operating parameters of these mining chains have been significantly improved without any loss in impact strength and deformability.

As the use of additional alloy constituents means higher material costs the added benefits of TIP Chains only begin to be felt on high-performance faces where the extra expenditure is soon offset by the higher face output and the higher working capabilities of the chains.

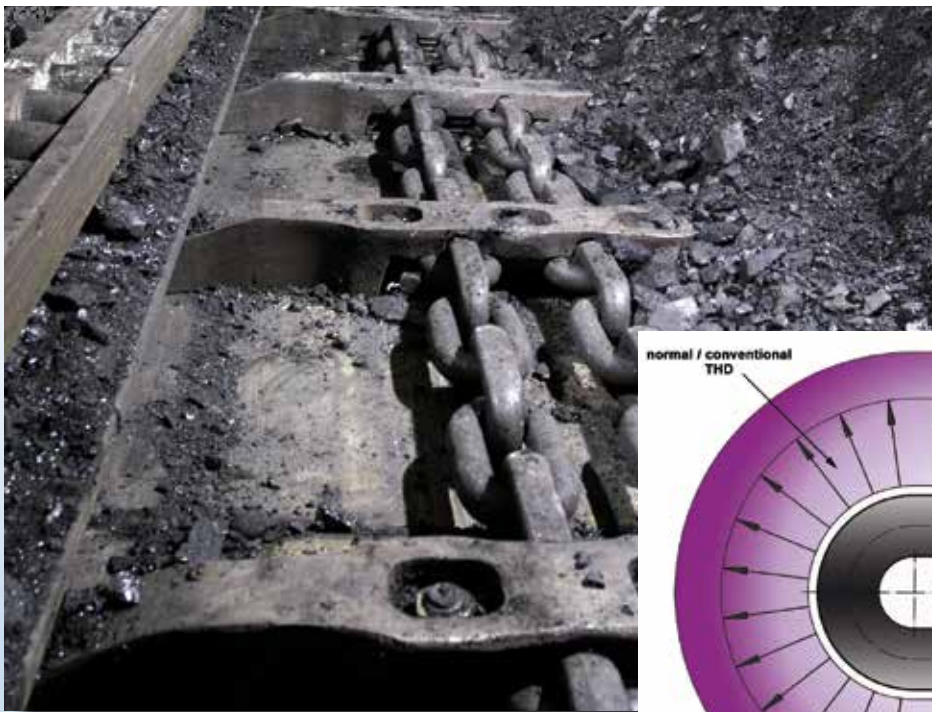

Picture: DBT

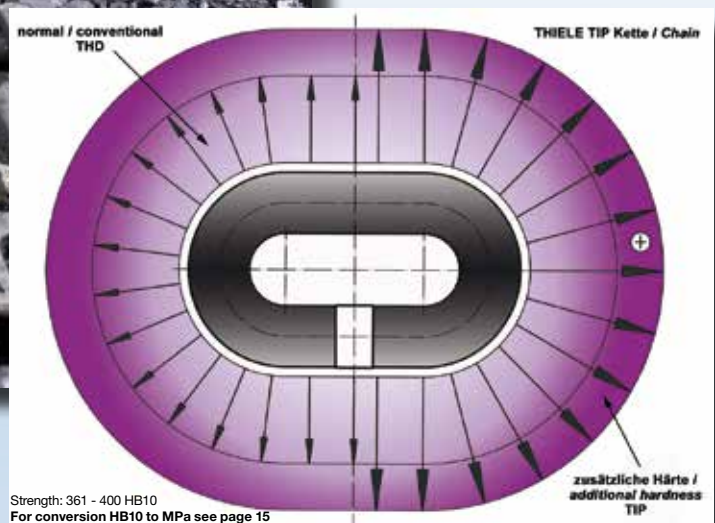

Chain Size d x t [mm]	Article No. TEC	Article No. TZN	Test Force kN	Elongation under test force % max.	Breaking Force kN min.	Elongation at fracture %	Minimum Deflection [mm]
30 x 108	F13658	on request	890	1,6	1.190	16	30
34 x 126	F13823	F13824	1.145	1,6	1.525	16	34

the above values apply to chains in 'natural black' condition (NSW)



THIELE Flat Type Chains

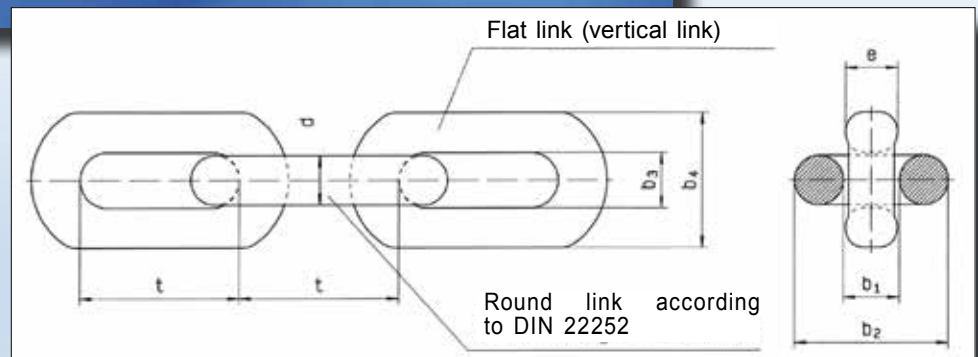

THIELE introduced another innovative product to the mining industry by inventing the flat-type chain in 1985. A flat-type chain is a round-link steel chain in which every second link – the vertical link – has flattened legs so that the overall height of the chain can be reduced.

This means that a chain conveyor can be upgraded to the next chain size with matching standard sprocket. THIELE Flat Type links can be produced by either welding and pressing or by forging (see DUALINK® chains).

Several years ago THIELE took things a stage further by developing its range of Super Flat Chains that again allow a chain conveyor to be upgraded from a Flat Type Chain to the next Super Flat Chain size, while retaining the standard sprocket (see page 26).

Some dimensions of THIELE's range of Flat Type and DUALINK® chains differ to DIN 22255, but represent long year practice / experience.



THIELE FEM-optimised DUALINK®-Chains

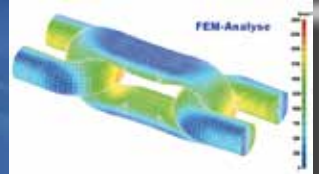

Weights and Dimensions (THD; TSC; TSD; TRQ; TIP; TZN) for Flat Type and DUALINK®-Chains

Chain Size d x t [mm]	Diameter d	Pitch t	Thick- ness e max.	Inside Width Round Link b ₁ min.	Outside Width Round Link b ₂ max.	Inside Width Flat Link b ₃ min.	Outside Width Flat Link b ₄ max.	Weight [kg/m]
24 x 86**	24 ± 0,7	86 ± 0,9	29	31	81	28	64	11,5
26 x 92*	26 ± 0,8	92 ± 0,9	30	31	85	29	75	13,7
30 x 108	30 ± 0,9	108 ± 1,1	34	34,5	98	33	87	18,0
34 x 126*	34 ± 1,0	126 ± 1,3	38	39	109	37	98	22,7
38 x 126*	38 ± 1,1	126 ± 1,3	42	41	121	41	110	30,1
38 x 137	38 ± 1,1	137 ± 1,4	42	41	121	41	110	29,0
38 x 146*	38 ± 1,1	146 ± 1,5	42	41	121	41	110	27,6
42 x 146	42 ± 1,1	146 ± 1,5	45,5	48	135	46	115	36,0
48 x 144/160*	48 ± 1,5	304*** ± 1,6	56	62	163	57	127	48,2
48 x 152	48 ± 1,5	152 ± 1,5	54	61	162	52	126	45,7
52 x 170**	52 ± 1,6	170 ± 1,7	63,5	65	177	57	135	55,5
56 x 187**	56 ± 1,7	187 ± 1,9	65	69	188	62	146	64,4
60 x 189**	60 ± 2,0	189 ± 2,0	70	69	198	63	156	73,9

* only as Flat Type Chain; ** only as DUALINK® Chain; *** module over two links



THD Flat Type Chains

TWN 0102

Chain Size d x t [mm]	Article No. TEC	Article No. TZN	Test Force kN	Elongation under test force % max.	Breaking Force kN min.	Elongation at fracture %	Minimum Deflection [mm]
26 x 92	F14965	F14971	637	1,6	850	11	26
30 x 108	F13771	F13773	848	1,6	1.130	11	30
34 x 126	F13807	F13808	1.090	1,6	1.450	11	34
38 x 126	F15051	F15052	1.360	1,6	1.820	11	38
38 x 137	F13891	F13893	1.360	1,6	1.820	11	38
38 x 146	F15076	on request	1.360	1,6	1.820	11	38
42 x 146	F15041	F15040	1.660	1,6	2.220	11	42
48 x 144/160	F14953	F14951	1.850	1,6	2.900	12	48
48 x 152	F14964	F14957	2.170	1,6	2.900	11	48

the above values apply to chains in 'natural black' condition (NSW)

THD DUALINK®-Chains

Chain Size d x t [mm]	Article No. TEC	Article No. TZN	Test Force kN	Elongation under test force % max.	Breaking Force kN min.	Elongation at fracture %	Minimum Deflection [mm]
24 x 86	F13484	on request	543	1,6	724	11	24
30 x 108	F13666	on request	848	1,6	1.130	11	30
38 x 137	F13918	F13917	1.360	1,6	1.820	11	38
42 x 146	F15021	F15015	1.660	1,6	2.220	11	42
48 x 152	F14956	F14954	2.170	1,6	2.900	11	48
52 x 170	F14974	on request	2.550	1,6	3.400	11	52
56 x 187	F14975	on request	2.960	1,6	3.950	11	56
60 x 189	F14976	on request	3.390	1,6	4.520	11	60

the above values apply to chains in 'natural black' condition (NSW)

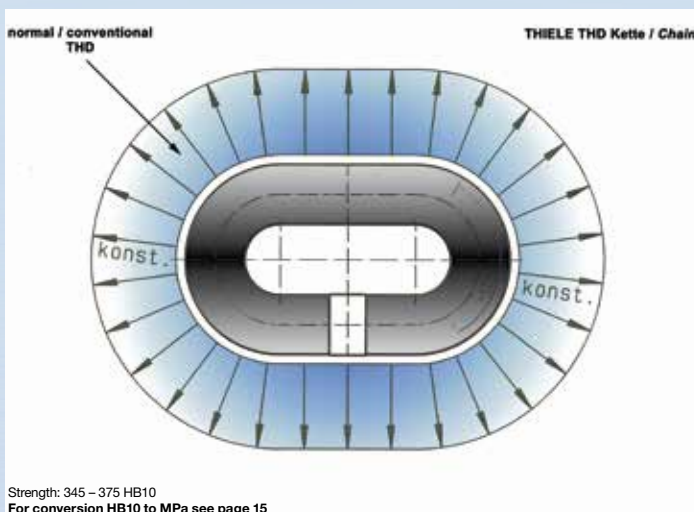

Strength: 345 – 375 HB10
For conversion HB10 to MPa see page 15

Most of the world's face conveyors now use Flat Type/DUALINK® Chains from the THD range.

THIELE offers the following types of corrosion protection for THD Flat Type/DUALINK® Chains, depending on underground conditions and storage times:

- a) Tectyl dipped (TEC) – for short storage times and good conditions (page 11)
- b) Hot-dip galvanised (TZN) – for longer storage times and corrosive operating conditions (page 12)



TSC Flat Type Chains

TWN 0026

Chain Size d x t [mm]	Article No.	Test Force kN	Elongation under test force % max.	Breaking Force kN min.	Elongation at fracture %	Minimum Deflection [mm]
26 x 92	F14966	637	1,4	940	11	26
34 x 126	F13801	1.090	1,4	1.610	11	34
38 x 126	F15054	1.360	1,4	2.010	11	38
38 x 137	F13912	1.360	1,4	2.010	11	38
38 x 146	F15086	1.360	1,4	2.010	11	38
42 x 146	F15023	1.660	1,4	2.450	11	42
48 x 152	F14959	2.170	1,4	3.250	11	48

the above values apply to chains in 'natural black' condition (NSW)

TSC DUALINK®-Chains

Chain Size d x t [mm]	Article No.	Test Force kN	Elongation under test force % max.	Breaking Force kN min.	Elongation at fracture %	Minimum Deflection [mm]
30 x 108	F13774	848	1,4	1.250	11	30
38 x 137	F13919	1.360	1,4	2.010	11	38
42 x 146	F13909	1.660	1,4	2.450	11	42
48 x 152	F14963	2.170	1,4	3.250	11	48

the above values apply to chains in 'natural black' condition (NSW)

TSC Flat Type / DUALINK Chains provide high wear resistant crowns (THIELE Super Crown) and are widely used / recommended in BSL-Applications.

TSC Chains are not recommended for corrosive environments – especially in face-conveyor applications – due to the risk of stress corrosion cracking.

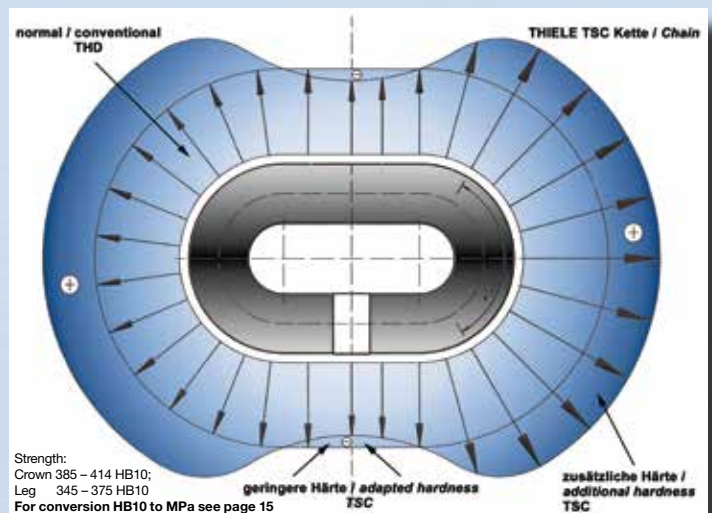



TSD Flat Type Chains

TWN 0025

Chain Size d x t [mm]	Article No.	Test Force kN	Elongation under test force % max.	Breaking Force kN min.	Elongation at fracture %	Minimum Deflection [mm]
26 x 92	F14962	740	1,6	1.050	11	21
30 x 108	F13772	990	1,6	1.400	11	24
34 x 126	F13799	1.270	1,6	1.800	11	27
38 x 126	F15066	1.590	1,6	2.250	11	30
38 x 137	F13996	1.590	1,6	2.250	11	30
38 x 146	F15085	1.590	1,6	2.250	11	30
42 x 146	F15049	1.940	1,6	2.740	11	34

the above values apply to chains in 'natural black' condition (NSW)

TSD DUALINK®-Chains

Chain Size d x t [mm]	Article No.	Test Force kN	Elongation under test force % max.	Breaking Force kN min.	Elongation at fracture %	Minimum Deflection [mm]
30 x 108	F13777	990	1,6	1.400	11	24
38 x 137	F13914	1.590	1,6	2.250	11	30
42 x 146	F13907	1.940	1,6	2.740	11	34

the above values apply to chains in 'natural black' condition (NSW)

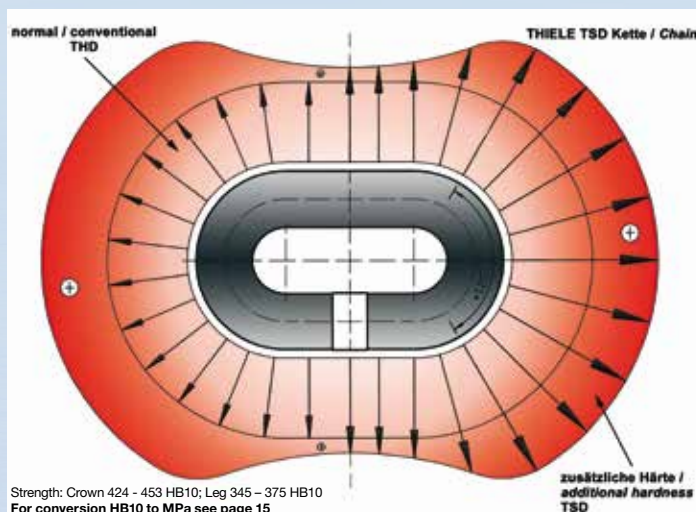

TSD Flat Type / DUALINK Chains provide very high wear resistant crowns (THIELE Super Duty) and are widely used / recommended in BSL-Applications.

TSD Chains are not recommended for wet or aggressive operating conditions as their high strength specifications make them susceptible to stress corrosion cracking.



TIP Flat Type Chains

Chain Size d x t [mm]	Article No.	Test Force kN	Elongation under test force % max.	Breaking Force kN min.	Elongation at fracture %	Minimum Deflection [mm]
38 x 126	F15051TIP	1.430	1,6	1.910	11	38
38 x 137	F13891TIP	1.430	1,6	1.910	11	38
38 x 146	F15076TIP	1.430	1,6	1.910	11	38
42 x 146	F15046	1.750	1,6	2.330	11	42
48 x 152	F14964TIP	2.280	1,6	3.040	11	48

the above values apply to chains in 'natural black' condition (NSW)

TIP DUALINK®-Chains

Chain Size d x t [mm]	Article No.	Test Force kN	Elongation under test force % max.	Breaking Force kN min.	Elongation at fracture %	Minimum Deflection [mm]
38 x 137	F13918TIP	1.430	1,6	1.910	11	38
42 x 146	F15020	1.750	1,6	2.330	11	42
48 x 152	F14967	2.280	1,6	3.040	11	48
52 x 170	F14974TIP	2.680	1,6	3.570	11	52
56 x 187	F14975TIP	3.100	1,6	4.140	11	56
60 x 189	F14976TIP	3.560	1,6	4.750	11	60

the above values apply to chains in 'natural black' condition (NSW)

THIELE TIP Chains have been developed for use on high-performance coal faces.

By employing special alloyed steel the main operating parameters of these mining chains have been significantly improved without any loss in impact strength and deformability.

As the use of additional alloy constituents means higher material costs the added benefits of TIP Chains only begin to be felt on high-performance faces where the extra expenditure is soon offset by the higher face output and the higher working capabilities of the chains.

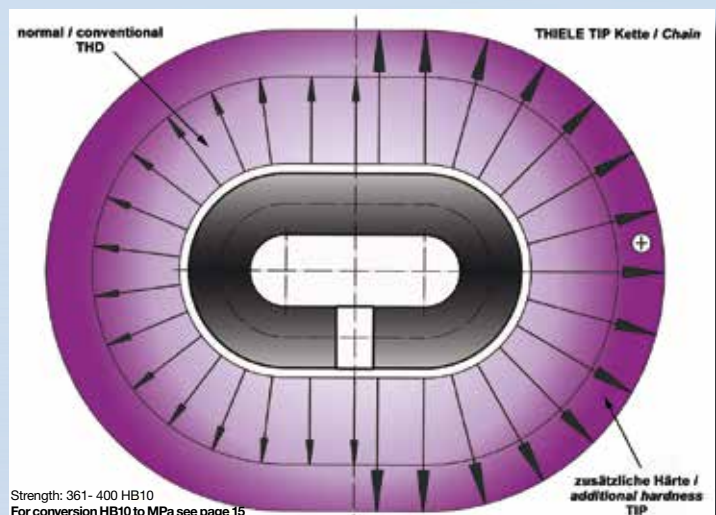



THIELE Super Flat Type Chains REINFORCED



THIELE Super Flat Type Chains / Super Flat Type Chains REINFORCED are mining chains for chain scraper conveyors that are a nominal size flatter than the standard Flat Type Chains. The advantage of the Super Flat design is that because the chain assembly is centrally embedded in the flight bar the Super Flat Type Chain / Super Flat Type Chain REINFORCED offers greater clearance in the pan profiles thus reducing wear grooves in the bottom plate. Super Flat Type Chains also allow the existing conveyor to be upgraded from a Flat Type Chain to the next Super Flat Type Chain size.

THIELE's patented 'REINFORCED' Super Flat Type Chain offers all the advantages of the THIELE Super Flat Type Chain, such as low design height, anti-kink stud and reduced tendency to develop chain slack.

In addition, the THIELE 'REINFORCED' Super Flat Type Chain features a significant strengthening of the wear zone in the crown, which gives the 'REINFORCED' version a much higher resistance to wear. This is of particular advantage when running chains of 42 mm and larger.

Additional advantages of Super Flat Type Chains REINFORCED:

- + the vertical links have a central full stud that prevents kinking and increases the chain breaking force
- + the central full stud and FEM-optimised shape of the vertical links increase the modulus of elasticity of the Super Flat Type Chains, which in turn helps reduce chain slack
- + available in different grades: THD, TSC, TSD, TIP and TZN
- + compatible with existing flight bars for Round Link or Flat Type Chains of the same nominal size



THIELE Super Flat Type Chains REINFORCED

strengthening of the wear zone in the crown THIELE Super Flat Type Chains REINFORCED

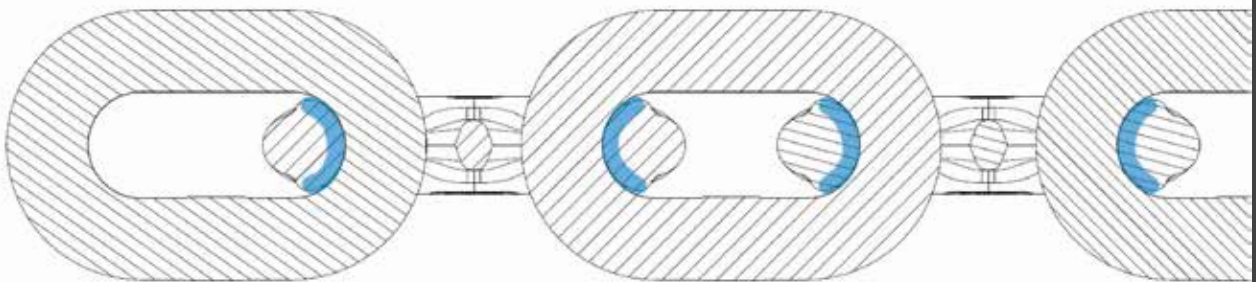

The service life of mining chains is often limited by the effect of wear on the chain links. When chain stretch exceeds 3 or 4% problems begin to arise at the interface between chain and sprocket. In order to extend the operating life of a chain it is necessary to reduce the rate of interlink wear and so slow down the chain elongation process. The solution patented by THIELE - which involves strengthening the forged vertical links on the super-flat chains - increases the contact surfaces of the chain links and creates a greater volume of material that has to be worn away by abrasion before chain elongation sets in.

Thanks to the 3D design process the crowns on the vertical links can be strengthened in such a way that all the design dimensions (which are critical for the compatibility of the chain with the scraper bars and sprockets) remain unchanged.

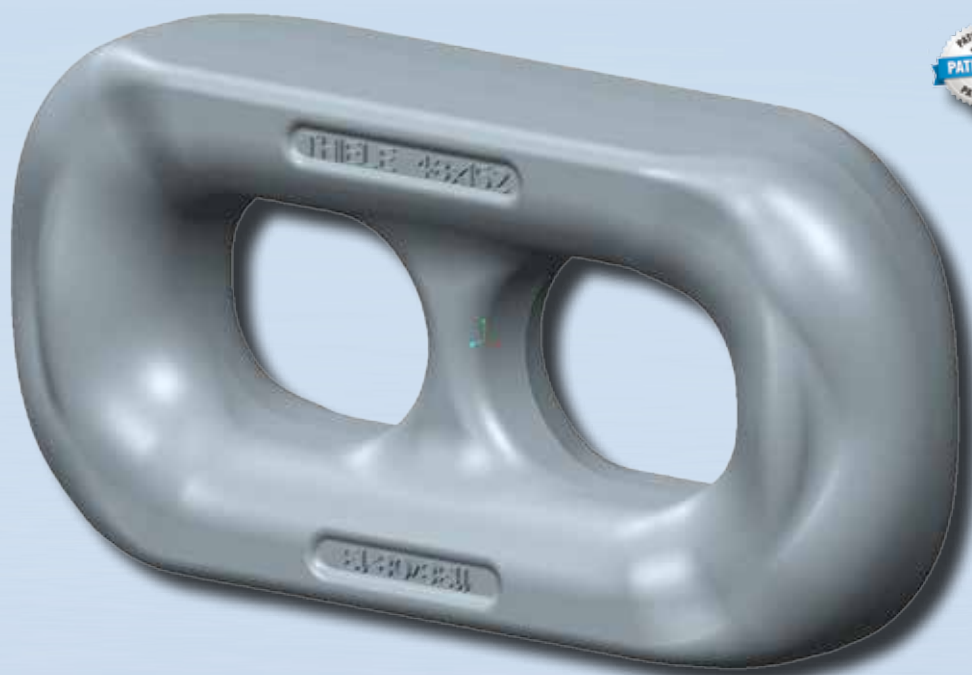



THIELE Super Flat Type Chains REINFORCED

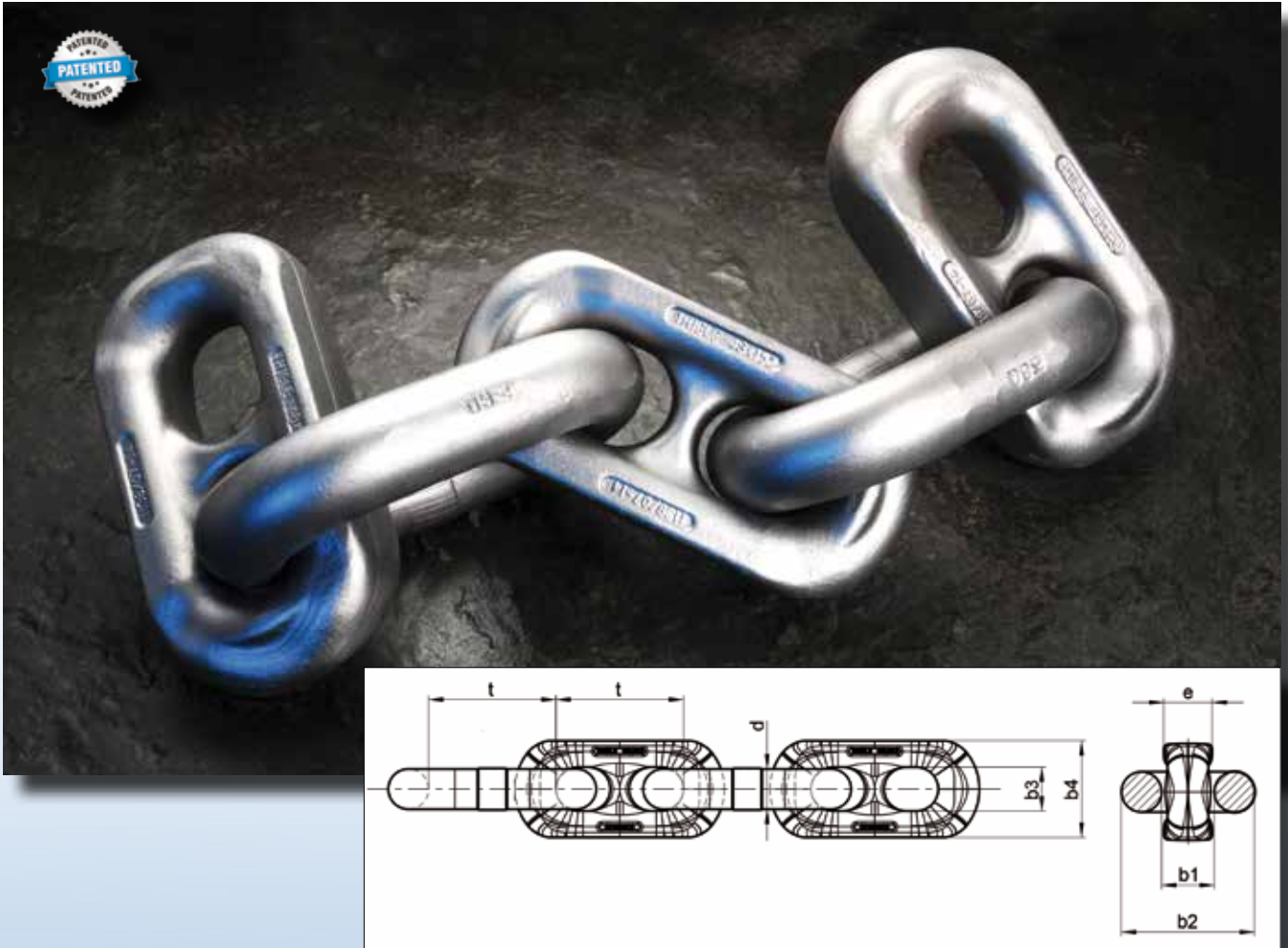

Weights and Dimensions (THD; TSC; TSD; TIP; TZN)

Chain Size d x t [mm]	Diameter d	Pitch t	Thick- ness e max.	Inside Width Round Link b ₁ min.	Outside Width Round Link b ₂ max.	Inside Width Flat Link b ₃ min.	Outside Width Flat Link b ₄ max.	Weight [kg/m]
30 x 108*	30 ± 0,9	108 ± 1,1	34,0	34	99	34,0	81,0	17,2
34 x 126*	34 ± 1,0	126 ± 1,3	37,0	38	111	38,0	91,0	22,9
38 x 126	38 ± 1,1	126 ± 1,3	42,2	40	123	42,0	101,3	29,5
38 x 126*	38 ± 1,1	126 ± 1,3	42,2	43	123	42,0	101,1	29,5
38 x 137*	38 ± 1,1	137 ± 1,4	42,2	43	123	42,0	101,1	28,5
42 x 146	42 ± 1,1	146 ± 1,5	47,3	48	135	45,5	110,7	36,6
48 x 144/160*	48 ± 1,5	304** ± 1,6	59,1	62	163	51,2	116,5	48,0
48 x 152	48 ± 1,5	152 ± 1,5	59,1	62	163	51,2	116,5	48,2
52 x 170*	52 ± 1,6	170 ± 1,7	63,5	65	177	56,0	128,0	52,4
56/60 x 187	56 ± 1,5	187 ± 1,9	65,2	71	189	61,0	132,0	62,0
62x181 / 58x197	60 n/a	378** ± 2,0	70,0	73	198	63,0	136,0	71,5

* without REINFORCED feature (normal Super Flat Type Chain); ** Modul over 2 links



THIELE Super Flat Type Chains REINFORCED

Mechanical Properties (THD; TZN)

Chain Size d x t [mm]	Article No. TEC	Article No. TZN	Test Force kN	Elongation under test force % max.	Breaking Force kN min.	Elongation at fracture %	Minimum Deflection [mm]
30 x 108*	F15133*	on request	848	1,6	1.130	11	30
34 x 126*	F15071*	F15082*	1.090	1,6	1.450	11	34
38 x 126*	F15088*	F15092*	1.370	1,6	1.820	11	38
38 x 137*	F15100*	F15102*	1.370	1,6	1.820	11	38
42 x 146	F15180	F15182	1.660	1,6	2.220	11	42
48 x 144/160*	F15073*	F15083*	1.850	1,6	2.900	11	48
48 x 152	F15190	F15192	2.170	1,6	2.900	11	48
52 x 170	F15196	on request	2.550	1,6	3.400	11	52
56/60 x 187	F15197	on request	3.000	1,6	3.940	11	56
62x181 / 58x197	F15103	F15104	3.390	1,6	4.520	11	58

* without REINFORCED feature (normal Super Flat Type Chain)

the above values apply to chains in 'natural black' condition (NSW)

Mechanical Properties (TSC)

Chain Size d x t [mm]	Article No.	Test Force kN	Elongation under test force % max.	Breaking Force kN min.	Elongation at fracture %	Minimum Deflection [mm]
34 x 126*	F15075*	1.090	1,4	1.570	11	34
38 x 126	F15035	1.360	1,4	1.960	11	38
42 x 146*	F15069*	1.660	1,4	2.420	11	42

* without REINFORCED feature (normal Super Flat Type Chain)

the above values apply to chains in 'natural black' condition (NSW)

Mechanical Properties (TSD)

Chain Size d x t [mm]	Article No.	Test Force kN	Elongation under test force % max.	Breaking Force kN min.	Elongation at fracture %	Minimum Deflection [mm]
34 x 126*	F15034*	1.270	1,6	1.800	11	27
38 x 126	F15031	1.590	1,6	2.250	11	38
42 x 146	F15181	1.940	1,6	2.740	11	42

* without REINFORCED feature (normal Super Flat Type Chain)

the above values apply to chains in 'natural black' condition (NSW)

Mechanical Properties (TIP)

Chain Size d x t [mm]	Article No.	Test Force kN	Elongation under test force % max.	Breaking Force kN min.	Elongation at fracture %	Minimum Deflection [mm]
34 x 126*	F150710*	1.145	1,6	1.530	11	34
38 x 126	F15088 TIP	1.430	1,6	1.910	11	38
42 x 146	F15070 TIP	1.750	1,6	2.330	11	42
48 x 152	F15188	2.280	1,6	3.040	11	48
52 x 170	F15101 TIP	2.680	1,6	3.570	11	52

* without REINFORCED feature (normal Super Flat Type Chain)

the above values apply to chains in 'natural black' condition (NSW)



THIELE BIG-T® Chains

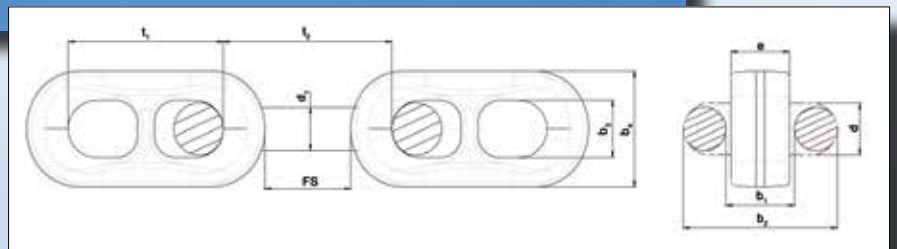

Weights and Dimensions

Chain Size d x t [mm]	Dia- meter d	Pitch t ₁	Pitch t ₂	Flight Bar Space FS	Thick- ness e max.	Leg ∅ Round Link d ₁ max.	Inside Width Round Link b ₁ min.	Outside Width Round Link b ₂ max.	Inside Width Flat Link b ₃ min.	Outside Width Flat Link b ₄ max.	Weight [kg/m]
34x121/131	34 ± 0,9	121 ± 1,3	131 ± 1,3	74	40	30,5 ± 0,8	45	109	38,0	84,1	20,20
42x140/152	42 ± 1,1	140 ± 1,5	152 ± 1,5	91	56,1	37,8 ± 1,1	67	148	45,1	99,1	34,10
48x144/158	48 ± 1,5	144 ± 1,5	158 ± 1,6	81	55	40 ± 1,1	64	149	54,3	109	38,70
52x156/171	52 ± 1,6	156 ± 1,6	171 ± 1,7	87	59	43 ± 1,3	69,5	161	58,3	118	45,50
56x168/184	56 ± 1,7	168 ± 1,7	184 ± 1,8	94	64	47 ± 1,5	75	173	62,3	126	52,80
60x181/197	60 ± 1,9	181 ± 1,8	197 ± 2,0	100	68	50 ± 1,6	80	185	66,3	135	61,00

Technical specifications subject to change



THIELE BIG-T® Chains

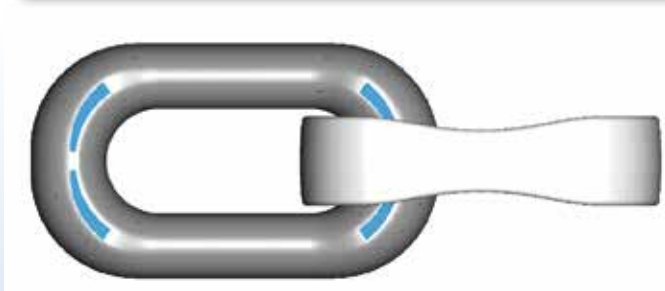
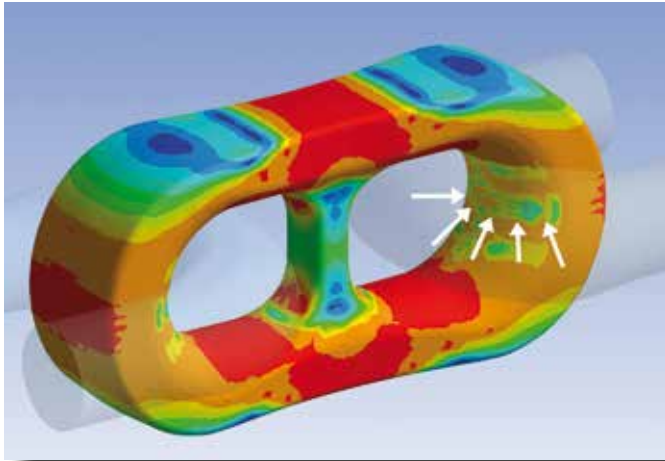

The newly developed multi-point contact principle of the Big-T chain allows the effective contact area to be increased by distributing the contact zone uniformly over the entire zone between the two outer endpoints. Contact pressure, and hence chain wear, is therefore significantly reduced.

The vertical link is also broader and flatter in design. This increase in width creates a much larger wearing surface and provides increased wear resistance, so that the overall wear behaviour of the chain is very much improved.

The flatter design of this chain – which is even flatter than the super-flat chain – makes it suitable for use on extremely compact conveyors (for low-seam applications*), or produces an extremely strong and durable chain for a given pan profile.

The round links have a flattened profile where they engage with the bottom of the chain pockets. This greatly improves the wear behaviour of the chain on the sprocket.

The leg diameter d_1 is much smaller than the nominal diameter d – without any loss in chain performance. The benefits include a 15% saving in weight at the round link and a larger volume of material at the critical flight-bar profile, which significantly increases the stiffness and breaking force of the flight bar.

In spite of the broader contact face the smaller d_1 value means that the round link is also narrower than that of a standard chain. The chain centre-to-centre spacing therefore remains unaltered, in spite of the larger nominal size.

Mechanical Properties (THD)

Chain Size d x t [mm]	Article No.	Test Force kN	Elongation under test force % max.	Breaking Force kN min.	Elongation at fracture %	Minimum Deflection [mm]
34x121/131	F15505	1.090	1,4	1.450	11	34
42x140/152	F15506	1.660	1,4	2.220	11	42
48x144/158	F15501	2.170	1,4	2.900	11	48
52x156/171	F15502	2.550	1,4	3.400	11	52
56x168/184	F15503	2.960	1,4	3.940	11	56
60x181/197	F15504	3.390	1,4	4.520	11	60

the above values apply to chains in 'natural black' condition (NSW) / Technical specifications subject to change



BROADBAND Low Profile Chain



"BROADBAND low profile chain" is a trademark of Joy Mining Machinery part of Joy Global Inc.

Mechanical Properties (THD, TZN)

Chain Size d x t [mm]	Art. No. TEC	Art. No. TZN	Test Force kN	Elongation under test force % max.	Breaking Force kN min.	Elongation at fracture %	Minimum Deflection [mm]
38x126/148	F13977	F13976	1.360	1,4	1.820	11	38
42x128/164	F13985	F13956	1.660	1,4	2.300	11	42
50x146/174	F13965	F13997	2.260	1,4	3.015	11	50
56x168/204	F13989	F13968	2.900	1,4	4.000	11	56
60x180/220	F13999	on req.	3.395	1,4	4.525	11	60

the above values apply to chains in 'natural black' condition (NSW)

For all face conveyors with normal and high production output demands, we recommend the THD grade chains. This THD grade was developed to provide the chain with the longest operating life under typical conditions of wear, corrosion, and fatigue.

Under very corrosive conditions, we recommend using the hot-dip galvanized TZN chains, which prevent any type of corrosion.



BROADBAND Low Profile Chain



Info:
The system uses THIELE BLOCKMASTER®-CP connectors. These are shown on page 34.

Mechanical Properties (TIP, TIP-TZN)

Chain Size d x t [mm]	Art. No. TEC	Art. No. TIP-TZN	Test Force kN	Elongation under test force % max.	Breaking Force kN min.	Elongation at fracture %	Minimum Deflection [mm]
38x126/148	F13975	F13979	1.420	1,4	1.895	11	38
42x128/164	F13986	F13957	1.740	1,4	2.320	11	42
50x146/174	F13966	F13964	2.360	1,4	3.140	11	50
56x168/204	F13967	F13969	3.050	1,4	4.060	11	56
60x180/220	F13955	on req.	3.680	1,4	4.760	11	60

the above values apply to chains in 'natural black' condition (NSW)

For all face conveyors with very high production output demands, specifically drive capacity and very high chain operating forces, the TIP chain grade was developed, which allows for a slightly higher breaking force with the same toughness. For situations demanding high drive capacity, or chain strength, which also contain a corrosive environment, the TIP hot-dip galvanized chains can be used without having to sacrifice breaking strength or impact strength.

Mechanical Properties (TSC)

Chain Size d x t [mm]	Art. No. TEC	Test Force kN	Elongation under test force % max.	Breaking Force kN min.	Elongation at fracture %	Minimum Deflection [mm]
38x126/148	F13978	1.360	1,4	2.010	11	38
42x128/164	F13980	1.660	1,4	2.450	11	42

the above values apply to chains in 'natural black' condition (NSW)

For all types of stage loader conveyor requirements, the TSC chain grade was developed for optimal resistance against wear.



BLOCKMASTER®-CP for BROADBAND Low Profile Chain

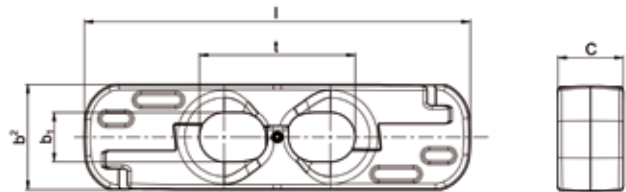

Chain Size d x t [mm]	Article No.	d	t	b ₁ min.	b ₂ max.	l max.	c max.	Breaking Force kN min.	Weight kg	Roll Pins Article No.
38 x 126/148	F26338*	38	126	40	86	313	54	2.050	8,4	Z03608 / Z00299
42 x 128/164	F26348*	42	128	44	99	341	60	2.500	11,9	Z03892 / Z00311
50 x 146/174	F26365*	50	146	52	116	367	65	3.390	16,0	Z03892 / Z00311
56 x 168/204	F26375**	56	168	61	130	401	75	4.000	22,8	Z10176 / Z10177

condition at time of delivery: galvanized or microzinc
* BLOCKMASTER-CP; ** BLOCKMASTER Ultra 3.1

the above values apply to connectors in 'natural black' condition (NSW)

SP-S Connector for BROADBAND Low Profile Chain

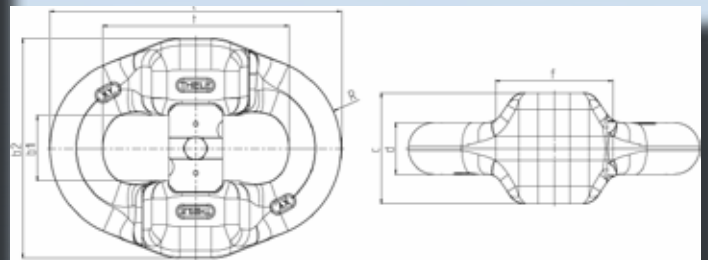
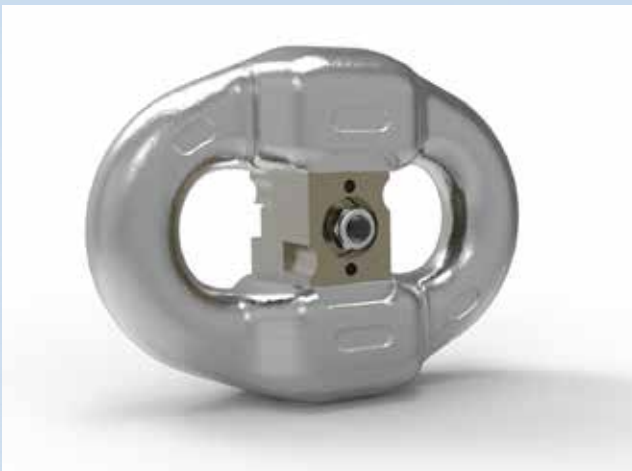

Chain Size d x t [mm]	Article No.	d	t	b ₂ max.	c max.	f max.	l max.	r +2	Work Force WF kN max.	Breaking Force kN min.	Weight kg
38 x 126/148	F26168	38	148	146	87	77	228	72	1.130	1.820	8,0

condition at time of delivery: galvanized

the above values apply to connectors in 'natural black' condition (NSW)











THIELE mining chain connectors



THIELE can supply a wide range of mining chain connectors. All our connectors are manufactured using the latest production methods and come with the THIELE 'long life' guarantee.

Product range – mining chain connectors:

- | | | |
|---|---------------------------------|-------------------|
|  | - Flat Type Connectors | page 36 |
|  | - TKF-Connectors | page 36 |
|  | - DMK-Connectors | page 37 |
|  | - SP Connectors | page 37 |
|  | - SP-S Connectors | page 38-39 |
|  | - BLOCKMASTER® | page 40-43 |
|  | - PLOWMASTER®-S | page 44 |
|  | - Power Chain Connectors | page 45 |

Flat Type Connectors

TWN 0142



The Flat Type Connector was specially developed for vertical and horizontal applications.

The mechanical properties are at least the equivalent of DIN 22258 Part 1.

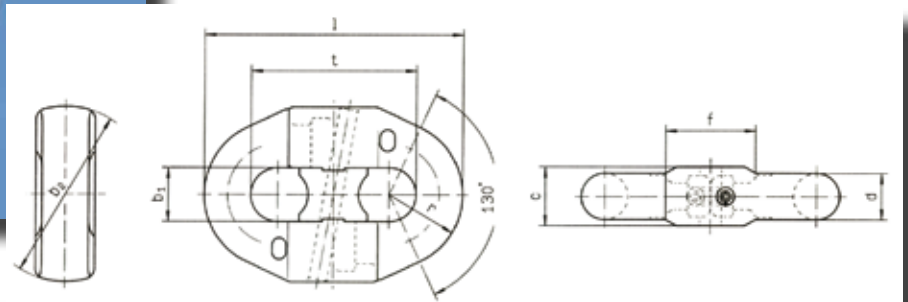

Chain Size d x t [mm]	Article No.	d	t	b ₁	b ₂	c	f	l	r	Work Force WF kN max.	Breaking Force kN min.	Weight kg
26 x 92	F 26220	26 ± 0,8	92 ± 0,9	28	96	33	62	147	40	531	754	1,8

condition at time of delivery: natural black (NSW)

the above values apply to connectors in 'natural black' condition (NSW)

TKF-Connectors

TWN 0145



The TKF connector has been developed for vertical (round link chains only) and horizontal applications.

The mechanical properties are at least the equivalent of DIN 22258 Part 1.

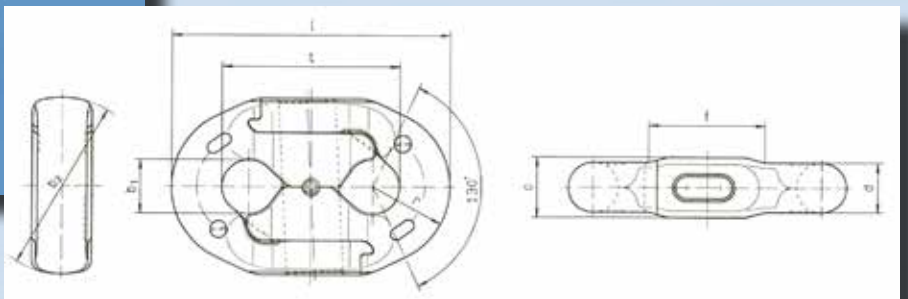

Chain Size d x t [mm]	Article No.	d	t	b ₁	b ₂	c	f	l	r	Work Force WF kN max.	Breaking Force kN min.	Weight kg
30 x 108	F26061	30 ± 0,9	108 ± 1,1	32	111	37	72	171	48	707	1.000	2,6
34 x 126	F26071	34 ± 1,0	126 ± 1,3	37	122	41	82	198	55	907	1.290	4,2
38 x 137	F26081	38 ± 1,1	137 ± 1,4	41	134	46	91	217	61	1.130	1.610	5,7

condition at time of delivery: galvanized

the above values apply to connectors in 'natural black' condition (NSW)



DMK-Connectors

TWN 0133

The DMK-Connector has been specially developed as a connecting link for twin inboard chains.

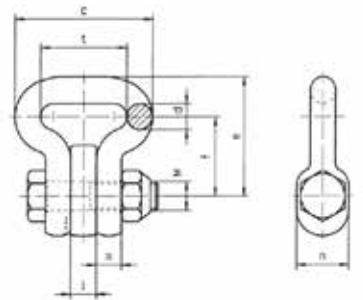

Chain Size d x t [mm]	Art. No.	d	t	c	e	f	i	m	n	Test Force kN	Break. Force kN min.	Bolt Nut	Tight. torque Nm	Weight kg
		± 0,5	± 1,0	min.	max.		max.	max.	+2					
22 x 86	F25211	24	86	132	117	78	25	24	52	440	550	M24	890	3,3
26 x 92	F25341	28	92	146	129	85	28	26	58	580	725	M30	1.775	4,4
30 x 108	F25401	32	108	172	147	98	32	31,5	65	725	905	M36	3.082	6,4
34 x 126	F25421	36	126	198	163	110	35	36,5	70	910	1.130	M36	3.082	8,0

condition at time of delivery: natural black (NSW)

the above values apply to connectors in 'natural black' condition (NSW)

Single Plane (SP) Connectors

TWN 0141

The Single Plane Connector is only suitable for horizontal applications.

The mechanical properties are at least the equivalent of DIN 22258 Part 2.

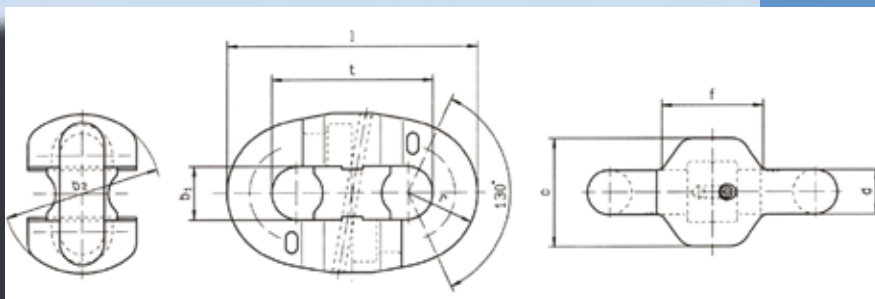
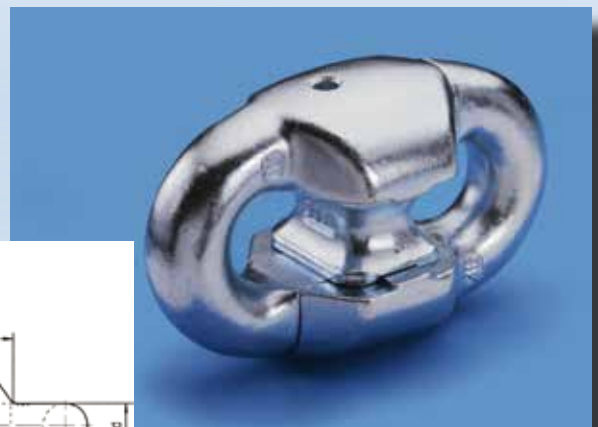

Chain Size d x t [mm]	Article No.	d	t	b ₁	b ₂	c	f	l	r	Work Force WF kN max.	Breaking Force kN min.	Weight kg
		± 0,7	± 0,9	min.	max.	max.	max.	max.	+2			
22 x 86	F26100	22	86	24	84	55	53	132	34	380	608	1,5
26 x 92	F26130	26	92	28	96	65	62	146	40	531	850	2,8
38 x 146	F26165	38	146	40	134	95	80	226	58	1.130	1.820	7,3

condition at time of delivery: natural black (NSW)

the above values apply to connectors in 'natural black' condition (NSW)

SP-S Connectors (Single Plane Screw-Type)



The SP-S Connector is an advanced development of the well proven SP-Connector-Design, with major improvements achieved by incorporating a new center lock that features a bolted connection. The “S” in the name denotes the bolted connection.

New are also the conical contact surfaces which hamper to cake both connector halves and support the disassembly.

The new locking system comprises of matching and interconnecting profiles that rotate on the same axis, thereby eliminating the risk of misalignment. This design allows for easy assembly and dismantling.





SP-S Connectors (Single Plane Screw-Type)

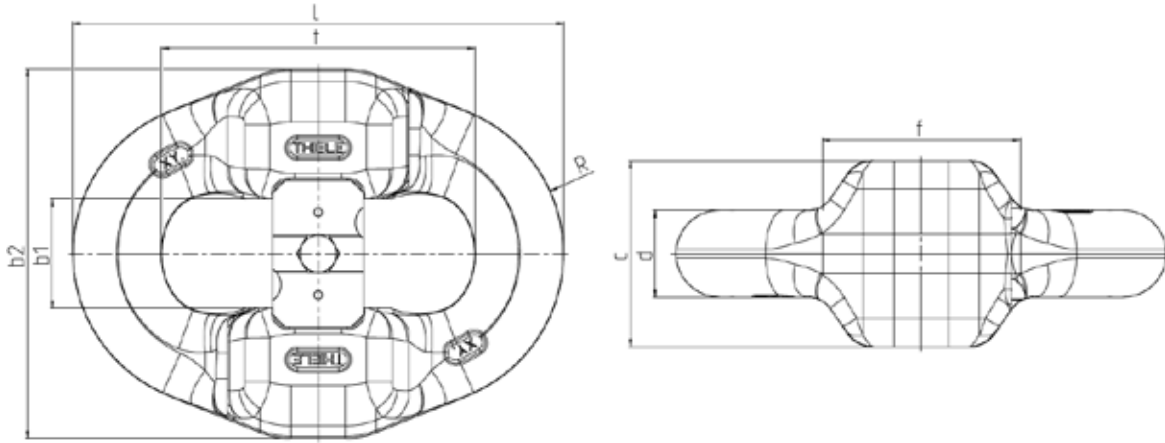

Chain Size d x t [mm]	Article No.	d	t	b ₁ min.	b ₂ max.	c max.	f max.	l max.	r -2	Work Force WF kN max.	Breaking Force kN min.	Weight kg
30 x 108	F26142	30 ± 0,9	108 ± 1,1	35	111	75	74	172	48	707	1.130	4,2
34 x 126	F26152	34 ± 1,0	126 ± 1,3	37	122	85	87	198	55	907	1.450	5,5
34 x 131 BIG-T	F26154	34 ± 1,0	131 ± 1,3	45	124	82	71	205	57	907	1.450	5,6
38 x 126	F26166	38 ± 1,1	126 ± 1,3	42	137	95	82	207	61	1.130	1.820	7,2
38 x 137	F26162	38 ± 1,1	137 ± 1,4	42	137	95	93	218	61	1.130	1.820	7,5
42 x 146	F26172	42 ± 1,3	146 ± 1,5	46	181	105	98	235	68	1.380	2.220	10,6
42 x 152 BIG-T	F26177	42 ± 1,3	152 ± 1,5	53	179	90	98	241	74	1.380	2.220	11,5

condition at time of delivery: galvanized

the above values apply to connectors in 'natural black' condition (NSW)

Spare Part Set: Center Lock Screw-Type

Chain Size d x t [mm]	Center Lock Screw Type Art. No.
34 x 126	F261521
34 x 131 BIG-T	F261541
38 x 126	F261661
38 x 137	F261621

Chain Size d x t [mm]	Center Lock Screw Type Art. No.
38 x 148 BB	F261681
42 x 146	F261721
42 x 152 BIG-T	on request

Accessories: Pin Punch



Pin Punches for the SP Connector are available under Art. No. F92201.



BLOCKMASTER[®]



ADVANTAGES

- **fast and easy to assemble**
 - extremely short locking movement
 - no chain slack needed
- **bi-directional**
 - installing without regard to the conveying direction
 - no danger of an installation error
- **kink risk free**
 - patented centre stud
- **long life**
 - robust construction
 - zinc coated

THIELE BLOCKMASTER®

TWN 0147

The THIELE BLOCKMASTER® has been specially developed as a vertical connecting link for Flat Type Chains. Its mechanical properties are much higher than those specified in DIN 22258 Part 3.

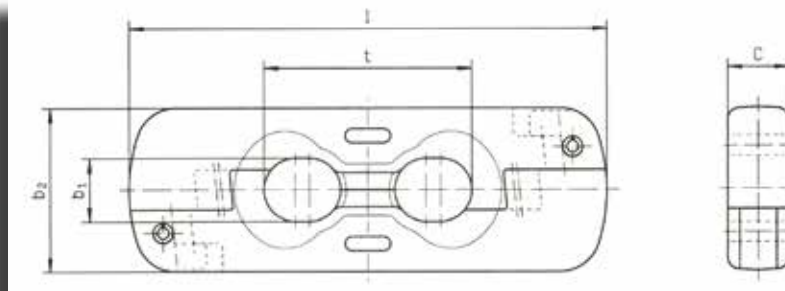

Chain Size d x t [mm]	Article No.	d	t	b ₁ min.	b ₂ max.	l max.	c max.	Breaking Force kN min.	Weight kg	Roll Pins Article No.
34 x 126	F26320	34	126	37	99	281	36	1.600	5,9	Z07862 / Z07863
38 x 126*	F26333	38	126	41	108	271	40	1.820	6,6	Z00448 / Z00083
38 x 137	F26335	38	137	41	110	310	40	2.000	8,2	Z07451 / Z07053
38 x 146	F26330	38	146	41	110	334	40	2.000	8,9	Z07451 / Z07053
42 x 146	F26341	42	146	44	115	334	44	2.500	9,8	Z06562 / Z07206
48 x 144/160	F26350	48	144	50	123	353	59	3.100	14,7	Z00302 / Z00303
48 x 152	F263621	48	152	50	128	339	56	2.900	13,4	Z08671 / Z09490

condition at time of delivery: galvanized or microzinc
*BLOCKMASTER-CP Edition (Central-Pin)

the above values apply to connectors in 'natural black' condition (NSW)

Assembly Instructions



1. Separate the two symmetrical connector halves



2. Lay chain ends into one connector half



3. Position connector halves over each other and push together

4. Drive in the roll pins





THIELE BLOCKMASTER® ULTRA 3.1

The THIELE BLOCKMASTER® ULTRA 3.1 has been specially developed as a vertical connecting link for Flat Type Chains. Its mechanical properties due to the special „twist-design“ are much higher than those specified in DIN 22258 Part 3.



Chain Size d x t [mm]	Article No.	d	t	b ₁ min.	b ₂ max.	l max.	c max.	Breaking Force kN min.	Weight kg	Roll Pins Article No.
42 x 146	F26345	43	146	44	110	331	44,0	2.500	9,8	Z10276 / Z10275
48 x 152	F26363	48	152	52	117	343	55,1	2.900	12,9	Z09490 / Z08671

condition at time of delivery: galvanized or microzinc

the above values apply to connectors in 'natural black' condition (NSW)





THIELE BLOCKMASTER® for S-Flat Type Chains

The THIELE BLOCKMASTER® has been additionally developed as a vertical connecting link for Super Flat Type / Super Flat Type Chains REINFORCED.



Chain Size d x t [mm]	Article No.	d	t	b ₁ min.	b ₂ max.	l max.	c max.	Breaking Force kN min.	Weight kg	Roll Pins Article No.
38 x 126*	F263331	38	126	41	101	271	40	2.000	6,4	Z00083 / Z00448
42 x 146*	F26344	42	146	44	108	316	44	2.350	8,4	Z00083 / Z00890
48 x 144/160	F26349	48	144	50	115	331	59	2.900	12,6	Z00916 / Z00303
48 x 152	F26357	48	152	50	116	339	56	2.900	12,4	Z09490 / Z08671
52 x 170	F26369	52	170	55	125	361	62	3.400	14,7	Z00916 / Z00303
56 x 187*	F26378	56	187	61	132	415	65	3.940	19,1	Z00420 / Z00342
60 x 181**	F26385	60	181	62	135	412	66	4.520	21,8	Z09490 / Z08671

*BLOCKMASTER-CP Edition (Central-Pin) ** BLOCKMASTER ULTRA 3.1
condition at time of delivery: galvanized or microzinc

the above values apply to connectors in 'natural black' condition (NSW)





THIELE PLOWMASTER®-S

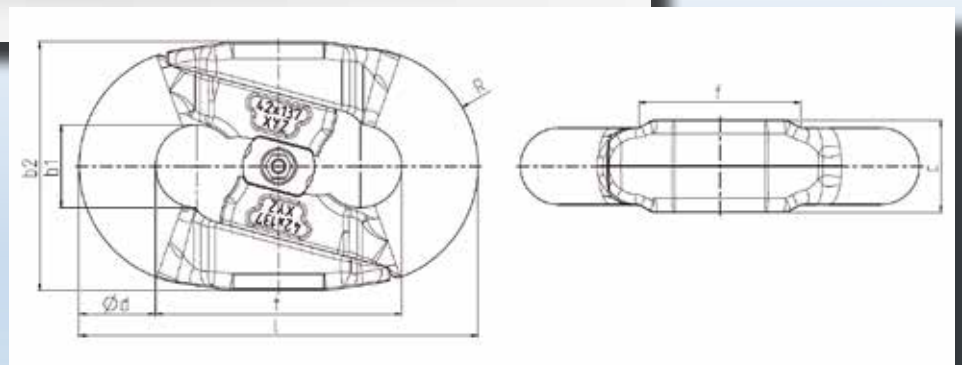

In modern plow systems operated with 42x137 mm round link chains at speeds of up to 3.6 m/s, the chain connectors are subject to much higher operational demands. In order to extend the operating life of the plow chain connectors, THIELE, with the support of FEM-Analysis, has developed a new concept.

After assessing numerous trial applications in high-performance operations underground, THIELE has optimized the design of the PLOWMASTER®-S, bringing it to operational maturity.

The THIELE PLOWMASTER®-S runs in the shadows of the plow chain, and is therefore protected from the formation of any contact fractures which may otherwise occur as a result of abrasive contact during operation. The screw lock of the PLOWMASTER®-S remain easy to open, even after long runtime.

Chain Size	Article No.	d	t	b ₁	b ₂	c	f	l	r	Breaking Force	Weight
d x t [mm]				min.	max.	max.	max.	max.	-2	kN min.	kg
42 x 137	F26274	42	137	45	139	52	91	222	67	1920	7

condition at time of delivery: galvanized
 Technical change without prior notice!

the above values apply to connectors in 'natural black' condition (NSW)



THIELE Connectors for Power Chain

THIELE BLOCKMASTER® for Power Chain



Chain Size d x t [mm]	Article No.	d	t	b ₁ min.	b ₂ max.	l max.	c max.	Breaking Force kN min.	Weight kg	Roll Pins Article No.
34 x 110	F26326	34	110	36	87	253	49	1.450	6,3	Z09008 / Z00351
42 x 140	F263461	42	140	44	108	325	62	2.500	12,0	Z00420 / Z00342

condition at time of delivery: galvanized or microzinc

the above values apply to connectors in 'natural black' condition (NSW)

THIELE Single Plane Connectors for Power Chain



Chain Size d x t [mm]	Article No.	d	t	b ₁ min.	b ₂ max.	l max.	c max.	Breaking Force kN min.	Weight kg	Roll Pins Article No.
34 x 110	F26256	34	110	37,8	167	179	61	1.460	7,8	Z03608 / Z00299
42 x 140	F26176	42	140	50,25	211	225	76	2.220	15,3	Z00988 / Z00318

condition at time of delivery: galvanized or microzinc

the above values apply to connectors in 'natural black' condition (NSW)



THIELE flight bar product range

THIELE offers a wide range of flight bars for face conveyors and stage loaders with chain sizes of $\text{Ø } 18 \text{ mm} - \text{Ø } 48 \text{ mm}$. All flight bars are drop forged, calibrated and sandblasted. The strength of the bar will depend on the material used. By using a precise heat treatment process THIELE is able to guarantee high notch-impact values at hardness levels of 270-380 HB. THIELE also offers flight bars with induction-hardened tips for special operating conditions.

THIELE flight bars are available in a range of different designs:

- | | |
|--|-------------|
| 1. S-Type Flight Bars (symmetrical bars with straps or bows) | pages 47-49 |
| 2. E-Type Flight Bars (split bars) | pages 50-51 |
| 3. Single Strand Flight Bars | page 52 |
| 4. Outboard Flight Bars DIN 22257 | page 53 |



THIELE S-Type Flight Bars with Strap / Bow

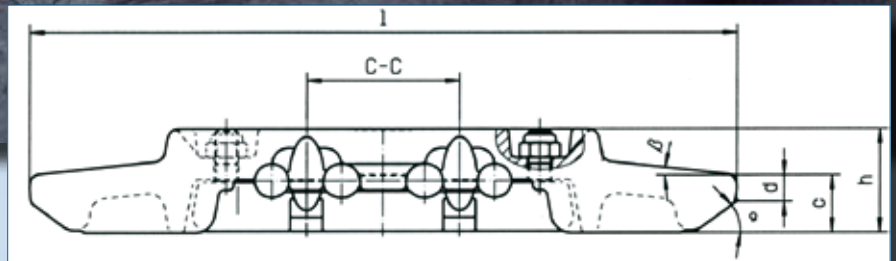
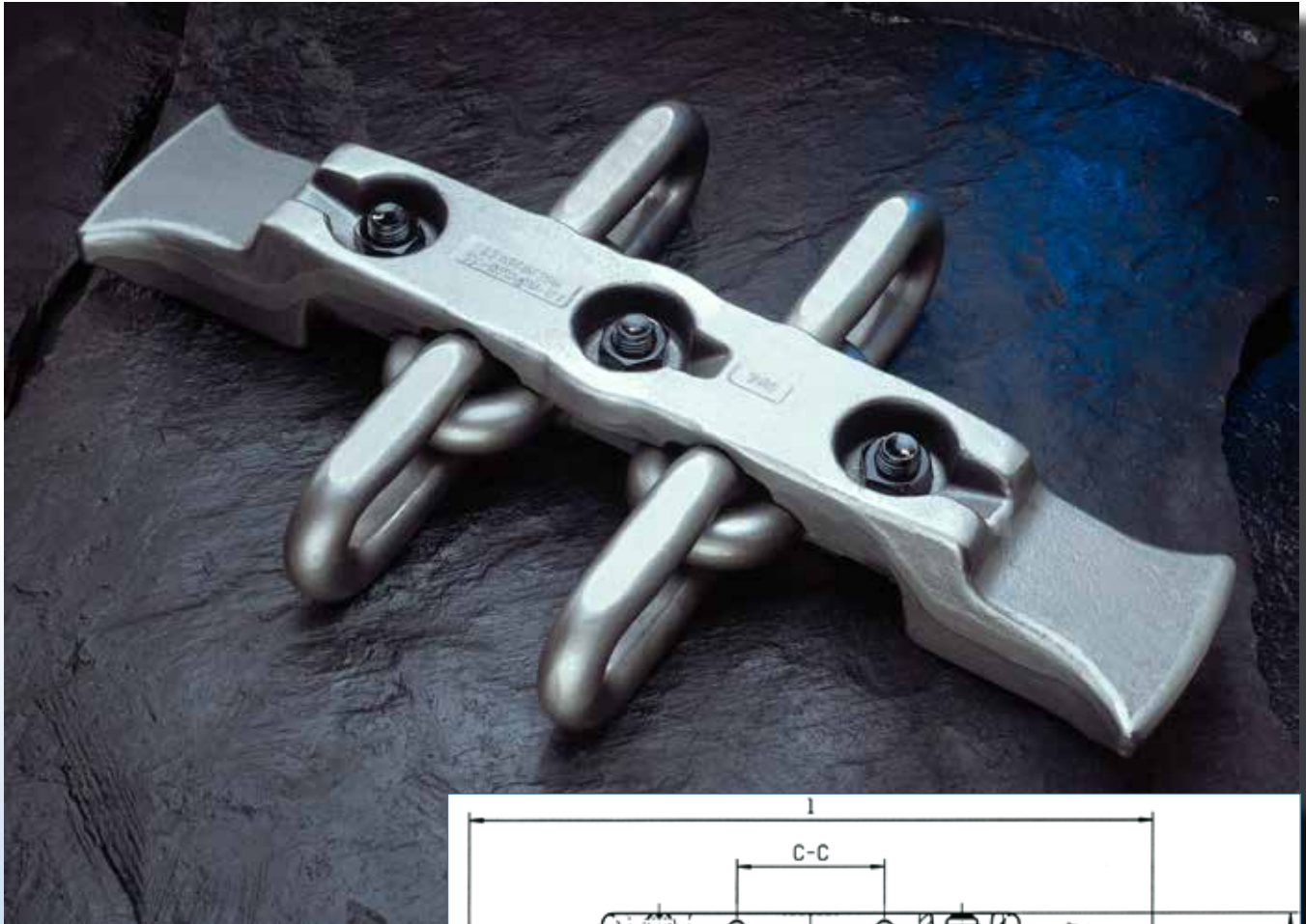

ADVANTAGES

- ⊕ long life time
- ⊕ compatible with original manufacturer's chain sprockets
- ⊕ high flexural strength
- ⊕ can be supplied with hex-head or hammer-head bolts
- ⊕ bi-directional
- ⊕ available with straps (a) or bows (b)

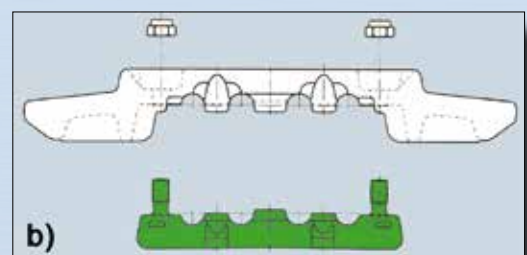
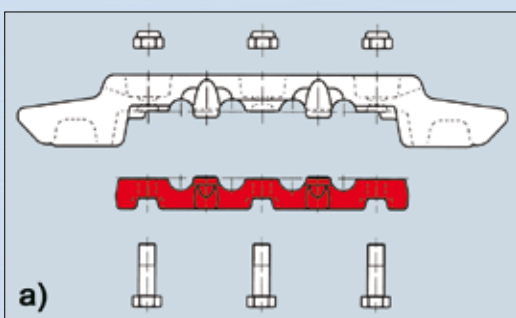

THIELE S-Type Flight Bars with Strap / Bow

Nominal Size	Designation	Art-No. complete	Art-No. Top Section	Art-No. Strap	G-No.	Chain C. CC [mm]	length [mm]	h [mm]	c [mm]	d [mm]	a [°]	β [°]	Weight appr. kg
22x86	SK/585/22/120	F24340	F24341	F24342	356/357	120	585	75	59,5	15	40	5	16,5
24x86	SK/590/24/120	F24345	F243451	F243452	304/305	120	590	81	59,5	15	40	5	17,1
26x92	SK/684/26/120	F24351	F243511	F243512	263/273	120	684	100	69	19	47	5	28,6
26x92 FI.	190x642/26/200	F24349	F243491	F243492	937/944	200	594	75	58	21	42	5	17,2
30x108	DMKF-3	F245060	F245061	F245062	413/414	130	673	101	46	13	30	20	29,8
30x108	HB280/780/30/130	F24503	F245031	F245062	507/414	130	696	110	77	29	45	13	35,8
30x108	988/30/200	F245200	F245201	F245122	1082/345	200	988	100	67	17	45	5	46,9
30x108	HB227/740/30/280	F245078	F245079	F245082	1282/930	280	740	101	50	19	30	17	34,0
30x108	PF2.30-832/772/30/115	F245087	F245088	F245089	1254/1255	115	772	100	52	18	34	20	35,1
30x108	PF2.30-732/672/30/115	F244865	F244866	F245089	1275/1255	115	672	100	52	18	34	20	29,0
30x108 FI.	676/30/140	F24510	F245101	F245102	991/992	140	676	110	55	21	35	19	32,5
34x126	PF3-822/34/150	F24553	F245531	F245532	887/888	150	682	117	57	21	55	19	37,7
34x126	PF4-932/34/150	F24556	F245561	F245532	908/888	150	772	114	67	22	55	19	55,5
34x126	PF4-932/34/130	F24557	F245571	F245541	169/252	130	775	114	65	20,5	60	20,5	46,5
34x126	PF4-932/34/145	F24547	F245471	F245472	778/779	145	772	114	67	22	55	18,5	46,5
34x126	PF2.30-732/34/130	F245540	F24554	F245541	251/252	130	676	115	52	17	35	19	39,0
34x126	776/34/150	F24551	F245511	F245532	253/888	150	776	113	R17,7	-	-	15	43,0
34x126	888/34/200	F245455	F245456	F245611	1084/1052	200	888	114	65	14	45	5	48,9
34x126	PF4-1132/34/130	F24539	F245391	F245542	1239/1240	130	976	115	65	20,5	60	19	60,8
34x126	PF4-832/34/130	F245393	F245394	F245542	1263/1240	130	676	115	65	20,5	60	19	40,0
34x126	1188/34/500	F245595	Z10655	F245597	1271/1272	500	1188	122	-	-	-	-	83,0
34x126 FI.	JT/789/34/160	F24545	F245451	F24546*	662/663	160	789	116	63	21	42	9	42,7
38x126 FI.	JT/888/38/200	F24582	F245820	F245821*	466/467	200	888	118	76	25	45	11	53,3
38x126 FI.	PF5-1342/38/330	F245895	Z09958	F2458951	1133/1134	330	1175	118	65	22	60	20	99,5
38x126 FI.	JT/988/38/240	F247015	F247016	F247017	1273/1274	240	988	94	51	19	45	11	53,0
38x126 FI.	PF6-1542/38/330	F245898	Z10463	Z10479	1248/1249	330	1375	125	60	19	60	20	87,0
38x126 FI.	1285/38/500	F245897	Z10724	F2458971	1280/1281	500	1285	116	-	-	-	-	82,0
38x137 FI.	788/38x137/200	F24574	F245740	F245761	1039/314	200	788	114	65	14	45	5	43,6
38x137 FI.	AT/784/38/200	F245745	F2457450	F245761	1119/0314	200	784	117	56	23	60	9	44,3
38x137 FI.	JT/988/38/200	F24576	F245760	F245761	329/314	200	988	118	75	24	45	11	61,7

* Art.-No. bow; compatible with PF4-1032

all dimensions given exclude forging tolerances

THIELE S-Type Flight Bars with Strap / Bow

Nominal Size	Designation	Art-No. complete	Art-No. Top Section	Art-No. Strap	G-No.	Chain C. CC [mm]	length [mm]	h [mm]	c [mm]	d [mm]	a [°]	β [°]	Weight appr. kg
38x137 Fl.	781/38/200	F24594	F245941	F245761	091/314	200	781	114	49,5	16	35	19	42,8
38x137 Fl.	977/38/200	F24584	F245840	F245761	451/329	200	977	114	54	R20	60	10	54,5
38x137FL	NW/882/38x137/170	F245945	F245946	F255947	1296/1297	170	882	114	50	30	50	9	47,4
38x146 Fl.	297x950	F245890	F24589	F24590	631/632	180	874	117	64	22	40	6	45,2
38x146 Fl.	JT/1268/38/345	F245970	Z06778	F24597	FC450/523	345	1268	116	54	22	41	8	72,0
42x146 Fl.	JT/988/42/220	F247280	F24728	F247291	075/076	220	988	126	70	20	48	8	70,1
42x146 Fl.	JT/925/42/200	F24591	Z00262	F24592*	FC066/487	200	925	134	74	34	36	6	65,2
42x146 Fl.	JT/878/42/200	F247252	F24725	F247261	708/206	200	878	126	66	20	46	8	57,6
42x146 Fl.	JT/988/42/165	F24600	Z06133	F247211*	ZC254/499	165	988	122	65	23,5	40	5,5	56,1
42x146 Fl.	PF4-1132/42/165	F24601	Z06341	F24721*	FC165/856	165	976	116	64	18	60	19	62,3
42x146 Fl.	PF6-1142/42/165	F246010	F2406012	F247311	1129/531	165	976	116	60	16	60	20	60,0
42x146 S-Fl.	PF6-1342/1176/42/330	F246035	Z10805	F246037	1284/1285	330	1176	125	60	19	60	20	73,0
42x146 Fl.	PF6-1342/42/165	F24603	Z10462	F246032	1246/1247	165	1175	125	60	19	60	20	72,0
42x146 Fl.	PF4-1332/42/165	F24602	Z06859	F24721*	ZC381/856	165	1170	125	60	18	59	20	74,8
42x146 Fl.	JT/926/42/200	F247270	F24727	F247262	181/709	200	926	126	66	20	46	8	60,6
42x146 Fl.	LPT988/42/220	F247320	F24732	F247291	641/076	220	988	122	65	23	41	5	59,8
42x146 Fl.	LPT878/42/220	F247340	F24734	F24736	730/735	200	878	121	55	29	37	5,5	52,8
42x146 Fl.	1088/42/220	F247370	Z09298	F247291	352/076	220	1088	126	76	23	45	9	76,3
42x146 Fl.	TH/878/42/200	F247254	F247255	F24736	840/735	200	878	126	66	21	45	8	52,8
42x146 S-Fl.	PF6-1042/42/165**	F247330	F24733	F24731	891/531	165	870	116	60	16	60	20	53,1
48x152 Fl.	JT/975/48/250	F24771	Z09411	F247707	691/695	250	975	129	64	16	60	20	66,8
48x152 Fl.	JT/988/48/280	F24772	Z09274	F247701	346/312	280	988	136	67	14,5	45	10	68,3
48x152 Fl.	JT/978/48/280	F24770	F247700	F2477010	311/312	280	978	135	76	22	45	10	67,8
48x152 Fl.	268x988/48/280	F247722	F247723	F2477011	1183/312	280	988	135	77,5	25	45	10	68,5
48x152 Fl.	222/988/48x152/250	F247705	F2477050	2477071	1267/1268	250	988	135	66	30	36	8	58,0
42x128/164	222/888/42BB/280	F246018	F246019	F246017	1279/1235	280	888	109	64	19	45	9	53,0
42x128/164	222/988/42BB/280	F246015	F246016	F246017	1234/1235	280	988	109	64	19	45	9	63,5
50x146/174	222/988/50BB/280	F24785	F247851	F247852	1243/1244	280	988	132	64	16	45	10	70,0

* Art.-No. bow; compatible with PF4-1032

all dimensions given exclude forging tolerances



THIELE E-Type (Split) Flight Bars



ADVANTAGES

- + low unit weight makes for easy handling
- + can be fitted with chain still under tension
- + compatible with original manufacturer's chain sprockets
- + calibrated chain recess

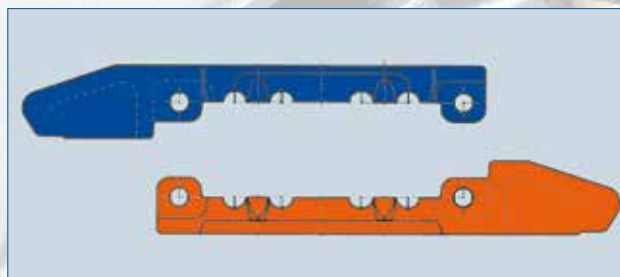

THIELE E-Type (Split) Flight Bars

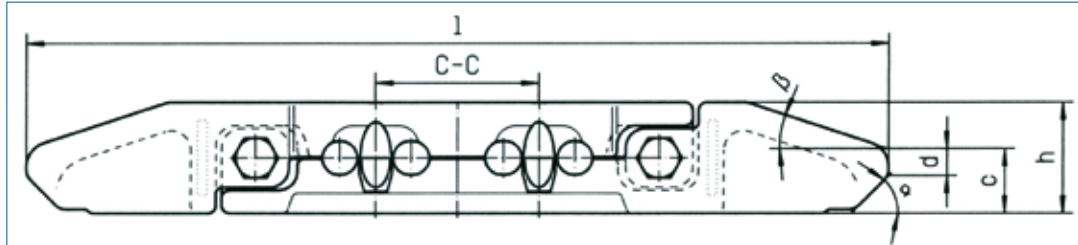

Nominal Size	Designation	Art-No. complete	Art-No. Top Section	Art-No. Bottom Section	G-No.	Chain Centre Distance CC [mm]	length [mm]	h [mm]	c [mm]	d [mm]	a [°]	β [°]	Weight appr. kg
22x86	PFI-500	F24310	H243107	H243157	686/687	85	590	75	60	22	45	5	16
26x92	PFII-600	F24418	H244227	H244177	317/318	100	712	89	65	20	45	9	24,1
26x92	PFII-600	F24427	H244267	H244277	945/946	120	712	89	65	20	45	9	24
26x92	PF2.30-732	F24430	H244357	H244307	899/900	100	672	88	55	12	38	20	21,2
26x92	DMKF3	F24392	H243957	H243907	271/272	120	673	92	46	13	30	20	22,8
26x92	222x724	F24448*	H244487	H244487	585/586	200	715	89	65	20	45	9	24,6
26x92	222x1064	F24438*	H244387	H244397	547/548	375	1012	89	65	20	45	8,5	34,6
30x108	DMKF3	F24506	H245067	H245117	239/240	130	673	101	46	13	30	20	27,6
30x108	222x764	F24463*	H2446217	H2446227	327/328	150	712	105	63	20	45	10,5	36
30x108	222x724	F24477*	H2447717	H2447727	629/630	200	712	104	65	20	45	9	32,2
30x108	222x824	F24475*	H244767	H244777	469/470	200	812	104	65	20	45	9	39
30x108	222x824	F24478	H244787	H244797	469/471	200	812	104	65	20	45	9	39
30x108	222x1024	F24492**	H244937	H244927	254/255	375	1012	104	65	20	45	8,5	48,9
30x108	R-1160	F24482**	H244837	H244827	141/142	375	1140	104	-	-	30x45°	30x45°	57
30x108	R-1160	F24490**	H244917	H244907	680/681	500	1140	104	-	-	30x45°	30x45°	57,6
30x108	R-1024	F244821**	H2448317	H2448217	433/434	375	1012	104	-	-	30x45°	30x45°	52,4
30x108	222x839/30/150	F24462*	H2446217	H2446227	834/835	150	787	102	64	18	45	9	35,7
30x108	JR/672/30/140	F244880*	H2448907	H2448807	1066/1067	140	672	108	51	14	35	19	31,4
30x108	JR/1006/30/375	F24544	H2454427	H2454417	1061/1062	375	1006	106	37	-	-	16	47,5
30x108	JR/784/30/280	F245430	H2454407	H2454307	884/885	280	784	105	70	16	45	6	35,9
34x126	JR/788/34/200	F245600*	H2456107	H2456007	965/966	200	788	114	52	16	35	19	44,3
34x126	PF4-1032 872/34/130	F24548	H245487	H245497	037/038	130	872	114	70	28	55	18,5	47,2
34x126	PF4-1032 872/34/145	F24549	H245492	H245491	871/872	145	872	115	67	26	55	18,5	47,5
34x126	R-PF-4-1132	F24538**	H245387	H245397	599/600	200	947	115	67	26	58	18	52,4
34x126	R-34/960	F24555*	H245557	H245567	379/380	200	947	115	67,5	26	45	8	51,6
34x126	34/1200	F24571*	-	-	FC905/FC906	500	1187	122	-	-	30x45°	30x45°	80,8
34x126	PF6-1042	F245491	H2454917	H2454927	514/515	145	872	115	60	15	60	21	48,5
38x126 FI	HB280/1000	F24583	H245837	H245847	047/048	160	914	114	77	14	45	13	50
38x137 FI	38-268/1000	F24580*	H2458017	H2458027	842/843	200	988	115	97,5	27	45	9	57,2
38x137 FI	PF280-880	F24596**	H245967	H245977	147/148	150	793	113	75	27	45	13	41,4
38x137 FI	268/900	F24577*	H2457717	H2457727	359/360	200	888	115	72,5	27	45	9	49,4
38x146 FI	JR/988/38/220	F24586*	H2458617	H2458627	395/396	220	988	127	78	30	45	10	62,4
42x128 BB	JT/988/BB42/280	F246100**	H2461007	H2461017	1109/1110	280	988	106	64	19	45	9	56,9
42x146 FI	JR/988/42/220	F24723*	H247237	H247247	671/672	220	988	127	78	30	45	10	62,1

* Art. No. without screws and bolts ** Art. No. for Huck-Bolts

all dimensions given exclude forging tolerances



THIELE Single Stand Flight Bar



THIELE Single Strand Flight Bars are designed for single-strand chain conveyors. The accurately forged and calibrated chain recess ensures a smooth chain run and prevents the flight bar from wandering out of the pan profile.

Nominal Size	Designation	Art-No. complete	Art-No. Top Section	Art-No. Bow	G-No.	length	h	c	d	a	β	Weight
						[mm]	[mm]	[mm]	[mm]	[°]	[°]	appr. kg
26x92	EKF2-26	F243600	F24360	F25662	723/R0248	576	90	40	13,5	30	20	16,1
30x108	EKF3-30	F24516	F24515	F25720	(704/231)	676	96	39	16	30	20	22,1
34x126	EKF34/776	F24536	F245361	F25821	935/Z0831	776	105	47	13,5	30	20	31
34x126	EKF34/676	F24537	F245371	F25821	935/Z0876	676	105	47	13,5	30	20	27

all dimensions given exclude forging tolerances

Induction-hardened tips

For extremely tough operating conditions – where there is a high rock content in the conveyed product – THIELE can supply flight bars with induction-hardened tips. Additional heat treatment increases the material hardness of the surface layer (which can be up to 15 mm thick) to 55 HRC.

The THIELE-Inductive hardening is much different to a flame hardening. The induction hardening provides a very precise distribution of the hard areas, and exactly at the wear areas. And the other areas, where high toughness is much necessary, are not affected from the hardening.

This process slows the rate of wear at the tips of the bars and therefore prolongs the life of the flights.

However, the decision to use induction-hardened tips requires some consideration as bars of this type can lead to increased wear at the pan profiles.

Typically for extreme abrasive conditions the overall cost saving with tip-hardened flightbars outnumbers the higher wear cost at the panline. However with the latest development for abrasive, but not extremely abrasive conditions THIELE is able to offer a mild tip-hardening with a tip-hardness of 40-44 HRC..

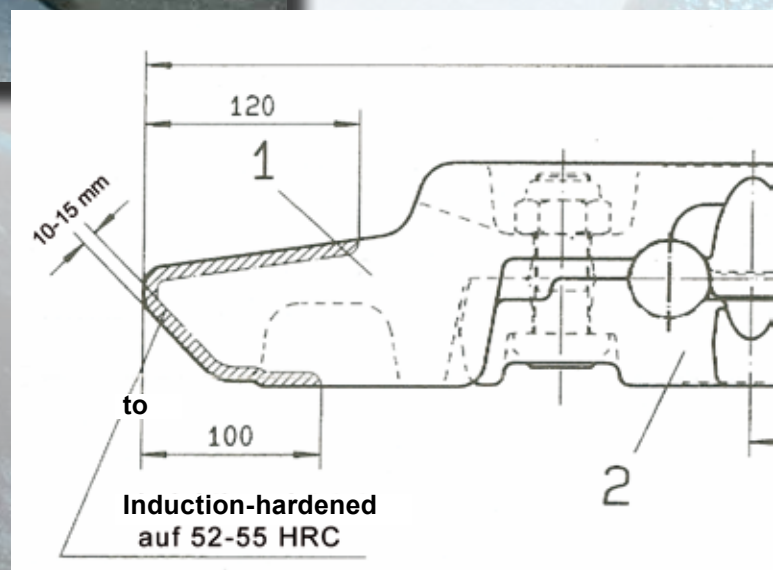



Outboard chain assemblies

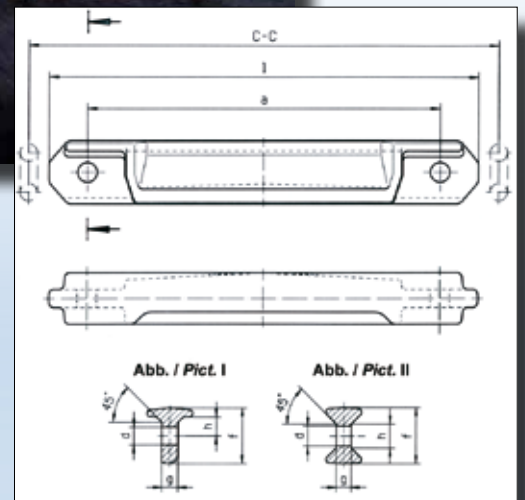

THIELE outboard chain assemblies are available for the following chain sizes: 18x64, 19x64,5, 22x86, 24x86 and 26x92 mm. All flight bars are forged and sandblasted and feature drilled holes. The tensile strength of the material after heat treatment is 270-320 HB. Chain connectors for outboard chain assemblies are manufactured according to DIN 22253 specifications.

Outboard flight bars DIN 22257

Nominal Size	Conveyor	Art-No.	Chain Centre Distance CC [mm]	Pict.	Length [mm]	a [mm]	d [mm]	f [mm]	g [mm]	h [mm]	Weight appr. kg
18x64/19x64,5	PFI-500	F24110	500	I	440	390	21,5	63	19,0	21,5	7,8
18x64/19x64,5	PFI-650 U*	F24260	650	I	590	540	21,5	63	19,0	21,5	10,8
22x86	PFII-600	F24211	600	I	548	450	25	80	23,0	26,5	13,8
24x86	PFII-600 SP301*	F24208	600	II	507	444	25	87	24,0	37,0	13,7
24x86	PFII-600*	F24210	600	I	542	444	26	77	25,0	26,0	13,4
26x92	PFIII-600	F24200	600	I	532	430	28	94	26,5	29,5	18,7

* not according to DIN 22257 specifications

all dimensions given exclude forging tolerances

Outboard chain connectors DIN 22253*

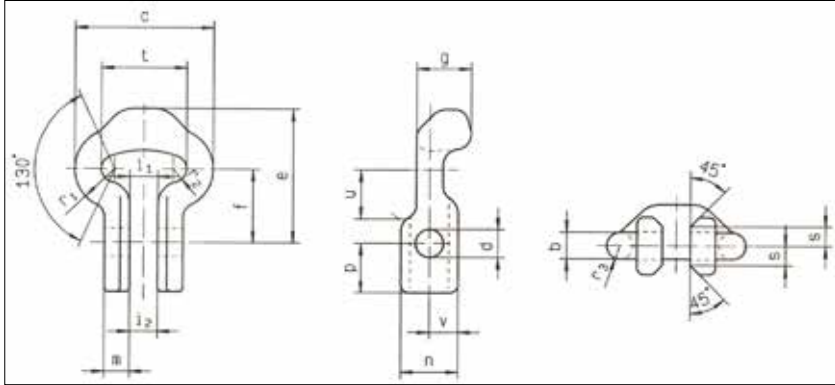

Nominal Size	Art-No.**	t	b	c	d	e	f	g	i ₁	i ₂	m	n	p ⁺¹ ₀	r ₁	r ₂	s	u	v	Wei. kg			
14x50	F25001	50,0 ± 0,5	15	+0,7 -0,5	78	+2 0	17	+0,5 0	78	51	29	18,0	+1,5 0	14,5	32	20	22,0	7,5	11,5	29	16,0	0,52
18x64	F25080	64,0 ± 0,6	19	+1,0 -0,5	100	+2 0	21	+0,5 0	100	55	40	21,0	+1,5 0	19,0	43	37	28,0	9,5	14,5	38	21,5	1,32
18x64***	F25082	64,0 ± 0,6	19	+1,0 -0,5	100	+2 0	21	+0,5 0	100	58	40	21,0	+1,5 0	19,0	43	34	28,0	9,5	14,5	38	21,5	1,32
19x64,5	F25151	64,5 ± 0,6	20	+1,0 -0,5	100	+2 0	21	+1 0	100	55	41	21,0	+1,5 0	19,0	43	37	29,5	10,0	14,5	38	21,5	1,36
22x86	F25201	86,0 ± 0,9	23	+1,0 -0,5	132	+2 0	25	+1 0	133	75	46	24,5	+1,5 0	22,5	52	44	34,0	11,5	17,0	51	26,0	2,47
24x86***	F25260	86,0 ± 0,9	26	+1,0 -0,5	138	+2 0	27	+1 0	126	78	52	25,5	+1,5 0	24,5	52	44	38,0	13,0	17,0	50	26,0	2,75
24x86***	F25265	86,0 ± 0,9	26	+1,0 -0,5	137	+2 0	27	+1 0	133	78	43	25,5	+1,5 0	24,5	52	44	38,0	13,0	18,0	50	26,0	2,60
26x92	F25310	92,0 ± 0,9	27	+1,0 -0,5	146	+2 0	28	+1 0	141	85	56	28,0	+2 0	26,0	58	42	40,0	14,0	19,0	56	28,0	3,45
26x92***	F253161	92,0 ± 0,9	28	+1,0 -0,5	148	+1,4 -1,4	28	+0,5 0	154	91	53	31,0	+2 0	27,5	53	41	41,0	14,0	---	62	26,5	3,00
30x108***	F253981	108,0 ± 0,9	31	+1,0 -0,5	170	+2 0	31	+0,5 0	178	115	58	32,5	+2 0	31,0	60	55	46,0	16,0	---	79	30,0	4,40

* DIN22253:1987; ** Art. no. only for bow; *** Note: these dimensions do not conform to DIN 22253:1987; condition at time of delivery: natural black (NSW)

Nominal Size d x t [mm]	Art.-No. ****	Hex-head bolt		Hex-head nut DIN 985			Work Force WF kN max.	Breaking Force kN min.	Weight kg
		Thread	Class	Thread	Class	Torque			
14x50	F25008	M16x65	8.8	M16	8	264 Nm	154	212	0,68
18x64	F25085	M20x90	10.9	M20	10	517 Nm	254	351	1,57
18x64***	F25086	M20x90	10.9	M20	10	517 Nm	254	351	1,57
19x64,5	F25158	M20x90	10.9	M20	10	517 Nm	283	391	1,52
22x86	F25204	M24x96	10.9	M24	10	890 Nm	380	525	2,94
24x86***	F25261	M24x105	10.9	M24	10	890 Nm	452	588	3,51
24x86***	F25266	M24x105	10.9	M24	10	890 Nm	452	588	3,21
26x92	F25311	M27x115	10.9	M27	10	1304 Nm	531	690	4,21
26x92***	F25316	M27x120	10.9	M27	10	1304 Nm	531	690	3,85
30x108***	F25398	M30x130	10.9	M30	10	1775 Nm	707	869	6,48

**** Art. no. for complete connector incl. nut and bolt; ** Note: these dimensions do not conform to DIN 22253:1987; the above values apply to connectors in 'natural black' condition (NSW)



THIELE Sprocket Rings / Assemblies

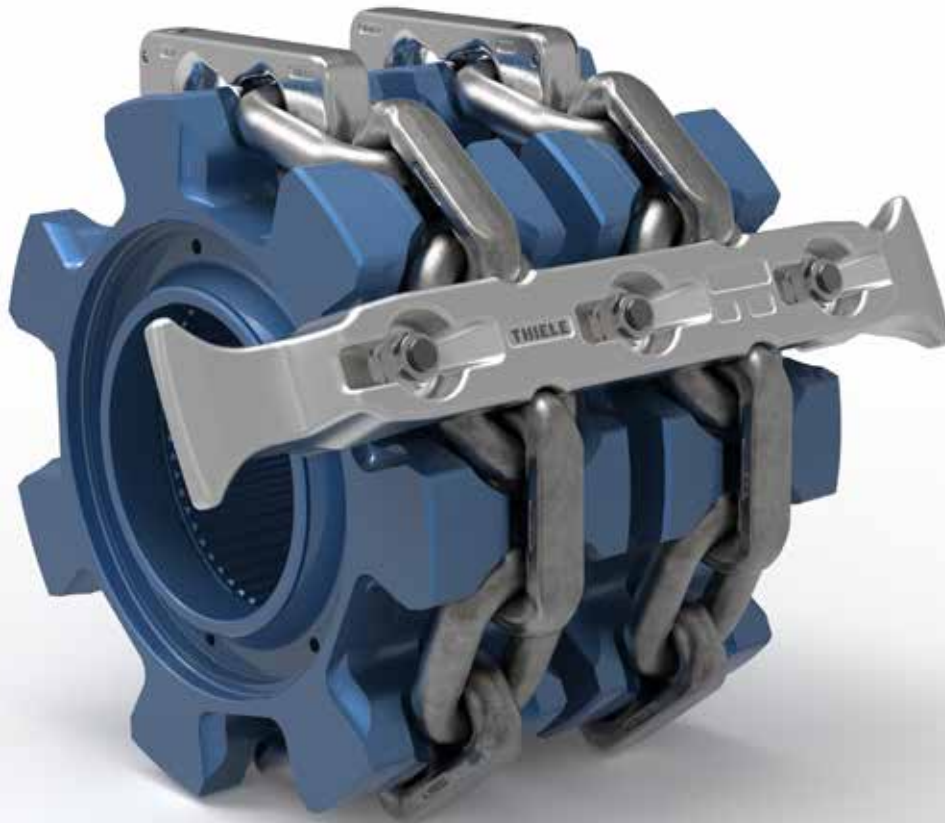

New

In March 2015, THIELE widened their range of products by taking over Richard Hippenstiel GmbH, a manufacturer of drive systems and corresponding components. Richard Hippenstiel GmbH was founded 1911 as a foundry and since became a globally recognized leader in the world of underground longwall mining.

By connecting two traditional, well-established German companies THIELE is now able to provide a complete system for chain conveyors. This ensures that chain and sprocket are ideally matched to one another.

The particular characteristic of THIELE sprockets is the special design of the sprocket pocket with „TD tothing“. The unique geometry of the tooth contour reduces the surface pressure with expanding pocket and chain wear. This significantly minimizes wear, or “duck tails”, at the outer face of the driven links.



THIELE Sprocket Rings / Assemblies



Design

The complex designs used for the sprockets meet the requirements of DIN 22256 and are drawn-up in-house as well as complete sprocket assemblies with the help of the latest computer-aided 3D CAD systems.

Load simulations based on the finite element method (FEM) make for optimum model dimensioning and allow a motion analysis to be undertaken of the overall system.



Manufacture

The factory is equipped with CNC machining units capable of producing sprockets of every type and design.

THIELE also supplies complete AFC and BSL drives and return ends, scraper-conveyor mountings, shafts and pulley wheels for crushers, sprockets with replaceable modules (e.g. teeth segments) for apron feeders and bucket elevators.



Heat Treatment

THIELE uses only alloyed tempering steels with high tensile strength (up to 1100 MPa).

The pocket areas are induction hardened after the CNC-machining. Thus, all areas which are in contact with the chain have a surface hardness between 56 and 60 HRC. Furthermore, depending on the nominal size, a hardness depth of up to 20 mm is achieved. The superior induction hardening and slower rate of wear allows maximum use of the tooth within its geometrical limits.



Operating experience and servicing

THIELE sprockets for mining conveyors are designed for chain sizes of 14 to 60 mm. The most popular sprocket types are now being used by clients all over the world.

In response to customer requests THIELE is able to assess the rate of wear at the sprockets and can retrofit or replace the components under workshop conditions.



THIELE cardan chains

Cardan chains with universal joints are able to move in all directions and are designed for use with high-speed conveyors (> 1 m/s) operating on tunnelling and roadheading machines.

THIELE cardan chains offer unbeatable ductility and wear resistance as a result of optimised heat treatment and the use high-quality materials.



TYPE	Chain Description	Flight Bar	Art.-No.	Ident-No.	Pitch p_1	Pitch p_2	Module m	Unit Length	Width
A	Universal joint	Standard	F91545	32-006-00	2 5/8"	2 5/8"	5 1/4"	15 3/4"	16,85"
	Universal joint	Standard	F91631	32-009-00	2 5/8"	2 5/8"	5 1/4"	15 3/4"	23 1/2"
	Universal joint	Standard	F91948	32-009-03	2 5/8"	2 5/8"	5 1/4"	15 3/4"	27 3/8"
	Universal joint	Standard	F91751	32-014-00	2 5/8"	2 5/8"	5 1/4"	21"	23 1/2"
	Universal joint	hardfaced	F9163100	32-015-00	2 5/8"	2 5/8"	5 1/4"	15 3/4"	23" +2x5,5mm hf
	Universal joint - Meter	---	F91577	32-007-00	2 5/8"	2 5/8"	5 1/4"	13 1/8"	---
B	Twin Pitch	Standard	F91558	32-005-00	2 5/8"	3"	5 5/8"	16 7/8"	27 1/4"
C	TC-Chain	curve-going	F91659	32-013-00	2 7/16"	2 13/16"	5 1/4"	15 3/4"	27 1/2"
D*	Cardan	Standard	F91964	32-016-00	71 mm	71 mm	142 mm	284 mm	325 mm
	Cardan	Standard	F91569	32-008-00	71 mm	71 mm	142 mm	284 mm	365 mm

* offered only with a permission of the patent owner



THIELE bushed conveyor chains

Bushed conveyor chains are laser-cut from materials of high tensile strength and ductility. They deliver optimum reliability combined with a long maximum operating life. These chains are typically used in the following applications:

- stacker / reclaimer
- plate link conveyors
- bucket elevators



THIELE forged link chains



THIELE manufactures forged link chains as complete assemblies and the company's in-house forging plant has access to a wide range of dies – which means that THIELE can supply a broad spectrum of designs for all commonly used chain pitches of 100 - 300 mm.





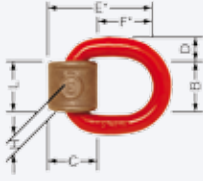

Lifting Points Grade 80

Trade Size	Art.-No.	Working Load Limit [t max]	Lashing Capacity [kN]	Marking DSK-N	Dimensions [mm]							Weight [kg]	
					E*	F*	C	L	H	D	B		
6-8	F35103	1,12	22	1	59	31	32	32	28	12	36	0,24	TWN 0119  Lifting Point weld-on type
8-8	F35113	2,00	40	2	69	37	38	38	33	14	42	0,46	
10-8	F35123	3,15	63	3	84	46	45	44	38	18	48	0,63	
13-8	F35133	5,30	100	5	120	69	60	60	51	24	66	1,90	
16-8	F35143	8,00	160	8	127	66	68	65	61	28	72	2,67	
22-8	F35163	15,00		15	178	98	96	109	80	39	120	8,09	
32-8	F35183	31,50		32	292	174	145	165	118	56	180	27,30	
40-8	F35193	50,00		50	371	228	186	210	145	72	230	60,00	

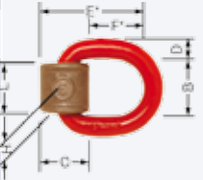
* E-and F-Dimension vertical to the welding level

Trade Size	Art.-No.	Working Load Limit [t max]	Tensile Force [kN]	Marking DSK-N	Dimensions [mm]							Weight [kg]	
					E*	F*	C	L	H	D	B		
6-8	F35107	1,12	22	1	56	30	32	32	28	12	36	0,25	TWN 0124  Lifting Point weld-on type with spring
8-8	F35110	2,00	40	2	67	37	38	38	33	14	42	0,43	
10-8	F35124	3,15	63	3	81	45	45	44	38	18	48	0,72	
13-8	F35139	5,30	100	5	117	69	60	60	51	24	66	1,90	
16-8	F35144	8,00	160	8	122	67	68	65	61	28	72	2,80	

* E-and F-Dimension vertical to the welding level

Trade Size	Art.-No.	Working Load Limit [t]	Marking DSK-N	Dimensions [mm]								Screw Size	Weight [kg]	
				E	F	A	C	L	D	B				
10-8	F35070	3,15	3	112	57	90	38	130	18	40	M16	1,54	TWN 0122  Lifting Point screwed type	
13-8	F35075	5,30	5	149	79	115	48	165	22	50	M20	2,83		
16-8	F35080	8,00	8	183	93	150	62	212	26	65	M30	5,87		
22-8	F35095	15,00	15	226	114	175	72	255	36	75	M36	11,20		
26-8	F35098	21,20	20	272	142	200	90	295	45	95	M42	19,30		
28-8	F35101	25,00	25	272	142	200	90	295	45	95	M45	20,20		
32-8	F35102	31,50	32	336	193	230	100	330	48	110	M56	31,70		
34-8	F35285	36,00	36	336	193	230	100	330	48	110	M56	31,70		





Lifting Points XL - Grade 100

Screw Size	Art.-No.	Working Load Limit [t] vertical	Thread Length [mm] G	Dimensions [mm]									Weight [kg]	
				E	F	D	T	B	A	SW	H	d		
M10	F34306	0,9	15	101	46,5	13	55	33	39	36	54,5	10	0,5	TWN 1830  X-TREME Lifting Point
M12	F34307	1,2	18	101	46,5	13	55	33	39	36	54,5	12	0,5	
M16	F34300	2,8	20	101	46,5	13	55	33	39	36	54,5	16	0,5	
M20	F34310	5,3	25	121	58,5	16	70	34	50	46	62,5	20	0,9	
M24	F34320	7	30	148	72	18	85	40	57	50	76	24	1,5	
M30	F34330	10	40	170,5	83	22	100	50	73	65	87,5	30	2,7	
M36	F34340	15	50	179	81	22	100	50	83	70	98	36	3,6	
M42	F34350	18	60	244	116	32	140	70	106	95	128	42	8,3	
M48	F34355	20	68	244	116	32	140	70	106	95	128	48	8,6	
M56	F34360	28	78	251	116	32	140	70	116	95	135	56	10,0	

Technical Datas at a glance

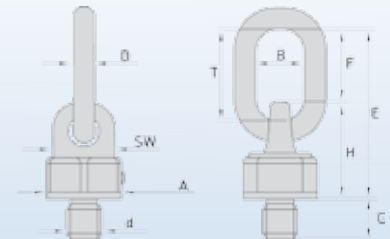
- Grade 100
- In threat size M10 - M56 available
- Due to integrated ball bearing very good appropriated for Lifting and Turnaround applications
- Turnable under load
- Compact design
- Thread transport protection
- Optimal surface protection
- Fast assembly with standard jaw spanner
- 100% crack tested
- 3D-Data on CADENAS-Platform available
- Occupational accidental insurance approved (GS M0 15-04)



Screw Size	Art.-No.	Working Load Limit [t max]	Thread Length [mm] G	Dimensions [mm]										
				E	F	D	T	B	A	C	H	K	L	
M10*	F35243	0,5	17	96	52,0	13	70	50	48	64	44,5	38,0	25,0	TWN 1890  XS-Point
M12*	F35244	0,8	22	96	51,0	13	70	50	48	64	45,5	38,0	25,0	
M16	F35245	1,7	30	97	47,0	13	70	50	48	64	50,0	40,0	25,0	
M20	F35246	2,5	38	98	43,5	13	70	50	48	64	54,5	42,0	25,0	
M24	F35247	4,0	40	134	70,0	16	102	58	50	71	64,0	49,0	28,0	
M30	F35249	6,0	44	149	73,0	20	110	70	65	87,5	75,0	56,5	35,0	
M36	F35250	8,0	63	191	102,0	24	145	84	78	106	89,0	66,5	43,0	
M42	F35251	10,0	73	191	98,0	24	145	84	78	106	93,0	66,5	43,0	
M48*	F35252	12,0	76	211	96,5	32	150	100	95	148	114,5	84,5	50,0	

* in development

Technical Datas at a glance

- Grade 100
- Extra wide D-bow
- 360° turnable
- Pre-fixed in working position (d. spring)
- Compact and light design
- Yellow thick-film passivated (chrome 6 free)
- 3D-datas on CADENAS Platform available
- Variable screw length upon request
- High value powder coating: RAL 5002
- Screw 100% crack tested
- Occupational accident insurance approved

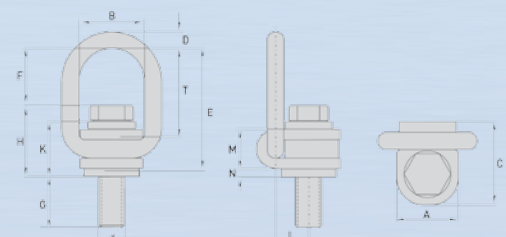

TM-Chain Block TWN 1000 TM-Lever Block TWN 1001



Specifications

- + with Overload Protection*
- + Lightweight robust steel construction
- + Super strength alloy loadchain as per EN818-7, galvanized and yellow chromated
- + Minimum headroom
- + Minimum effort to raise maximum load by easy handling
- + Hooks with strong cast steel safety latches
- + Lower hook easy turnable with roller bearing
- + Also approved for tensioning as per EN 12195 (only TM-Lever Block)
- + Fully enclosed gear train (TM-Chain Block only)
- + Protected automatic Weston brake with unique Twin Pawls
- + galvanised handchain as standard (TM-Chain Block only)
- + Durable baked enamel paint protection
- + Spare parts almost all available
- + TÜV / GS / CE approved
- + Supply with individual test certificate and manual in 7 languages
- + Approved for mining acc. to ATEX/68+69 (PN-EN 13463-1:2003)



TM-Chain Block
Capacities
500 kg to 5 tonnes

Advantages of the overload protection at TM-Series:

- + Prevents the hoist to be overloaded to a point when it becomes dangerous
- + Protects the hoist from damages
- + Protects the operator from injury
- + Provides additionally safety
- + Longer service life
- + Complies with DIN EN 13157, BGV-D8 und GPSG



TM-Lever Block
Capacities 250 kg*
to 6 tonnes

* Except TM-LB 250 kg



TM-Chain Block TWN 1000

Lifting capacity 500 kg to 5 tonnes

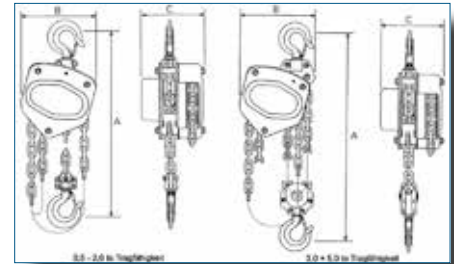

Lifting capacity	500 kg	1,0 to	2,0 to	3,0 to	5,0 to
Article No.	F06351	F06361	F06371	F06381	F06391
Article No. for special lifts**	F06355	F06366	F06375	F06385	F06396
Standard lift [m]	3	3	3	3	3
Falls of chain	1	1	1	2	2
Effort to lift W.L.L. [kg]	23	30	35	27	41
Net weight [kg]	10	12	22	32	46
Loadchain diameter [mm]	6	6	8	8	10
Headroom (A) [mm]	270	317	414	465	636
Width (B) [mm]	127	158	187	210	253
Depth (C) [mm]	131	140	161	161	161
Hook opening upper [mm]	36	42	46	54	62
Hook opening lower [mm]	36	42	46	54	62

TM-Lever Block TWN 1001

Lifting capacity 250 kg to 6 tonnes

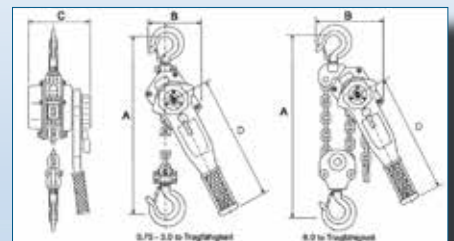

Lifting capacity / lashing force	250 kg*	0,75 to	1,5 to	3,0 to	6,0 to
Article No.	F06190	F06241	F06251	F06261	F06271
Article No. for special lifts**	F06194	F06245	F06255	F06265	F06275
Standard lift [m]	1,5	1,5	1,5	1,5	1,5
Falls of chain	1	1	1	1	2
Effort to lift W.L.L. [kg]	2,5	14	22	32	34
Net weight [kg]	1,8	7	11	21	31
Loadchain diameter [mm]	4	6	8	10	10
Lever Length (D) [mm]	160	280	410	410	410
Headroom (A) [mm]	230	325	380	480	620
Width (B) [mm]	85	136	160	180	235
Depth (C) [mm]	92	148	172	200	200
Hook opening upper [mm]	25	42	46	54	62
Hook opening lower [mm]	25	42	46	54	62

* without overload protection
** Special lifts upon request



Accessories: chain gauge



Measuring chain length is a useful way to assess the condition of the chain and determine the optimum maintenance routine (chain management).

Basic kit	Art. No.
Shatterproof and waterproof plastic case	Z08606
Leather pouch	Z08881
Gauge tool – sliding arm with scale	Z08879
Gauge tool – fixed arm	Z08880
Allen key 3 mm	Z08915
Wrench 6 mm	Z08916

Adapter	Art. No.
Pitch P = 64 mm	Z08868
Pitch P = 86 mm	Z08869
Pitch P = 92 mm	Z08870
Pitch P = 108 mm	Z08871
Pitch P = 126 mm	Z08872
Pitch P = 126 mm Langvers. 8xp	Z10310
Pitch P = 137 mm	Z08873
Pitch P = 146 mm	Z08874
Pitch P = 152 mm ; 144/160 mm	Z08875
Pitch P = 189 mm	Z10168
for Broadband 38 mm	Z09385
for Broadband 42 mm	Z09395
for Broadband 50 mm	Z08876
for Broadband 56 mm	Z10167
for Broadband 60 mm	Z10663
for Power Chain 34 mm	Z08878
for Power Chain 42 mm	Z08866
for Power Chain 52 mm	Z08867



additional adapter pieces available on request

Accessories: chain saws



THIELE supplies pneumatic and hydraulic saws for use underground. These can be employed not only as chain saws but also for cutting other items such as pipes and roadway supports up to a diameter of 180 mm.

Air Band Saws

Art.-No.	Cutting Capacity Ø	Cutting Capacity □	Power	Air consumption	Overall length	Height incl. Motor	Width	Air Connection	Hose ID	Housing Material	sound pressure level	vibration value	weight
	mm	mm	kW	m ³ /min	mm	mm	mm		mm		dB(A)	m/s ²	kg
Z10318 (6003)	115	115x120	0,5	0,55	550	240	220	R1/4"i	7	Alu	86,8	<2,5	6,2
Z08352 (6030)	107	107x120	0,7	0,9	550	240	210	R1/2"i	13	E-Stahl	76,3	<2,5	9,5
Z09521 (6032)	120	120x180	0,7	0,9	630	240	220	R1/2"i	13	E-Stahl	76,3	<2,5	9,9
Z07823 (6031)	180	180x180	1,0	1,2	730	290	285	R1/2"i	13	E-Stahl	81,7	<2,5	13,0

Technical changes without prior notice

Performance data for operating pressure of 6 bar

Hydraulic Band Saws

Art.-Nr.	Cutting Capacity Ø	Cutting Capacity □	Power	Operating pressure	Oil flow	Quick Coupling	Overall Length	Housing Material	sound pressure level	vibration value	weight
	mm	mm	kW	bar	l/min	mm	mm		dB(A)	m/s ²	kg
Z10206 (6043)	107	107x120	1,5	140	15-50	1/2" FF	550	E-Stahl	81,7	2,6	10,0
Z10228 (6042)	120	120x180	1,5	140	15-50	1/2" FF	630	E-Stahl	81,4	2,8	10,4
Z08368 (6041)	180	180x180	1,5	140	12-50	1/2" FF	730	E-Stahl	81,7	2,7	13,5
Z10229 (6054)	180	180x240	1,5	140	12-50	1/2" FF	838	E-Stahl	81,5	2,7	16,1

Technical changes without prior notice

Performance data for operating pressure of 140 bar



Accessories: pretensometer



Correct chain pretension is essential not only to ensure troublefree conveying and a safe working environment but also to help prolong the service life of the chain and sprockets. THIELE can supply a full range of pretensometers for chains of Ø 26 – 48 mm.

Pretensometer for chain	Art. No.	Weight approx. kg
26 x 92	Z08008	50
30 x 108	Z08946	52
34 x 126	Z08947	54
38 x 126	Z10424	54
38 x 137	Z08984	55
42 x 137	Z10426	86
42 x 146	Z08985	87
48 x 144/160	Z10425	90
48 x 152	Z08986	90
Broadband 42x128/164	Z10423	93
Broadband 50x146/174	Z10018	98

Operating Instructions Mining



Operating Instructions Mining for conveyor chains, plough chains and chain gauge are available in the following languages:

- German
- English
- Spanish
- Polish
- Russian
- Chinese

How to find us



Driving directions to THIELE:

Werkstr. 3, 58640 Iserlohn-Kalthof

From A 45: Leave motorway at the Hagen intersection and take the A 46 to Iserlohn. Leave the motorway at the Iserlohn-Seilersee exit and take the B233 (Baarstrasse) direction Unna. In Kalthof turn left at the traffic lights into Leckingser Str. and then turn right immediately after the railway underpass.

From A 44: Leave the motorway at the Unna-Ost exit and take the B233 (A 443) direction Iserlohn. In Kalthof turn right at the traffic lights into Leckingser Strasse and then turn right immediately after the railway underpass.



THIELE[®]



THIELE GmbH & Co. KG

Werkstr. 3
58640 Iserlohn - Kalthof
Germany

Phone +49 23 71 9 47 - 0
Fax +49 23 71 9 47 - 267
Internet www.thiele.de
eMail mining@thiele.de

THIELE APP



CHANGE[®]
for Success